

**Current Information:****I. A.) DEPARTMENT NAME:** \_\_\_\_\_**B.) COURSE NUMBER, and TITLE:** \_\_\_\_\_**C.) CREDIT HOURS:** \_\_\_\_\_ **D.) PREREQUISITES:** \_\_\_\_\_**E.) CURRENT CLASSIFICATION**

1. General Education Code:  B  C  D  H  M  N  P  S  None
2. Writing Requirement:  E2  E4  E6  None
3. Math Requirement:  M  None

**Requests:****II. GENERAL EDUCATION**A.) Requested Classification:  B  C  D  H  M  N  P  SB.) Effective Date:  Fall  Spring  Summer \_\_\_\_\_(year)

Or

 1-time Approval  Fall  Spring  Summer \_\_\_\_\_(year)**III. WRITING REQUIREMENT** **MATH REQUIREMENT** A.) Requested Classification  E2  E4  E6B.) Effective Date:  Fall  Spring  Summer \_\_\_\_\_(year)

Or

 1-time Approval  Fall  Spring  Summer \_\_\_\_\_(year)**C.) Assessment:**

- 1.) What type of feedback will be provided to the student (in reference to writing skill)?

\_\_\_\_\_ Grade \_\_\_\_\_ Corrections \_\_\_\_\_ Drafts \_\_\_\_\_ Other

- 2.) Will a published rubric be used? \_\_\_\_\_

#### IV. ATTACH A DETAILED SYLLABUS

#### V. SYLLABUS CHECKLIST

Courses that offer students General Education and/or Writing Requirement credit must provide clear and explicit information for the students about the classification and requirements.

For courses with a **General Education** classification, the syllabus **must** include:

- Instructor contact information (and TA if applicable)
- Course objectives and/or goals
- Student Learning Outcomes
- Required and optional textbooks
- Methods by which students will be evaluated and their grades determined
- Weekly course schedule with sufficient detail (including topics, assigned readings, assignments, due dates) that the General Education Committee may determine the appropriateness of the General Education classification requested.
- A statement related to class attendance, make-up exams and other work such as: *“Requirements for class attendance and make-up exams, assignments, and other work in this course are consistent with university policies that can be found in the online catalog at: <https://catalog.ufl.edu/ugrad/current/regulations/info/attendance.aspx>.”*
- A statement related to accommodations for students with disabilities such as: *“Students with disabilities requesting classroom accommodations should first register with the Disability Resource Center (352-392-8565, [www.dso.ufl.edu/drc/](http://www.dso.ufl.edu/drc/)) by providing appropriate documentation. Once registered students will an accommodation letter which must be presented to the instructor when requesting accommodation. Students with disabilities should follow this procedure as early as possible in the semester.”*
- A statement informing students of the online course evaluation process such as: *“Students are expected to provide feedback on the quality of instruction in this course by completing online evaluations at <http://evaluations.ufl.edu>. Evaluations are typically open during the last two or three weeks of the semester, but students will be given specific times when they are open. Summary results of these assessments are available to students at <https://evaluations.ufl.edu/results>.”*
- Information on current UF grading policies for assigning grade points. This may be achieved by including a link to the appropriate undergraduate catalog web page <https://catalog.ufl.edu/ugrad/current/regulations/info/grades.aspx>.

It is **recommended** that syllabi contain the following information:

- Critical dates for exams and other work
- Class demeanor expected by the professor (e.g. tardiness, cell phone usage)
- The university's honesty policy regarding cheating, plagiarism, etc.  
*Suggested wording: UF students are bound by The Honor Pledge which states, "We, the members of the University of Florida community, pledge to hold ourselves and our peers to the highest standards of honor and integrity by abiding by the Honor Code. On all work submitted for credit by students at the University of Florida, the following pledge is either required or implied: "On my honor, I have neither given nor received unauthorized aid in doing this assignment." The Honor Code (<http://www.dso.ufl.edu/sccr/process/student-conduct-honor-code/>) specifies a number of behaviors that are in violation of this code and the possible sanctions. Furthermore, you are obligated to report any condition that facilitates academic misconduct to appropriate personnel. If you have any questions or concerns, please consult with the instructor or TAs in this class.*
- Phone numbers and contact sites for university counseling services and mental health services: <http://www.counseling.ufl.edu/cwc/Default.aspx>; 392-1575, University Police Department 392-1111 or 9-1-1 for emergencies.

The University's complete Syllabus Policy can be found at:

[http://www.aa.ufl.edu/Data/Sites/18/media/policies/syllabi\\_policy.pdf](http://www.aa.ufl.edu/Data/Sites/18/media/policies/syllabi_policy.pdf)

For courses with **Writing Requirement (WR)** classification, the syllabus **must** include:

- "The Writing Requirement ensures students both maintain their fluency in writing and use writing as a tool to facilitate learning."
- "Course grades now have two components: To receive writing credit, a student must receive a grade of "C" or higher and a satisfactory completion of the writing component of the course."
- A statement or statements indicating that the instructor will evaluate and provide feedback on the student's written assignments with respect to grammar, punctuation, usage of standard written English, clarity, coherence, and organization
- Assignment word counts, page lengths, submission deadlines and feedback dates

Additionally, the syllabus must clearly show that the course meets the WR to

- Evaluate [2,000/4,000/6,000] written words in assignments during the semester
- Provide all feedback on assignments prior to the last class meeting

**Important note:** The following types of writing assignments **CANNOT** be used to meet the WR: teamwork, exam essay questions, take-home exams, and informal, ungraded writing assignments.

**VI. SUBMISSION AND APPROVALS**

Department Contact:

Contact Name: \_\_\_\_\_

Phone \_\_\_\_\_ Email \_\_\_\_\_

College Contact:

College Name: \_\_\_\_\_

College Contact Name: \_\_\_\_\_

Phone \_\_\_\_\_ Email \_\_\_\_\_

**General Education Committee Meeting**

November 7, 2014

Meeting was called to order at 8:30am

**Present:** Timothy Brophy, Shannon Cochrane, Elayne Colon, Eva Czarnecka-Verner, Creed Greer, Christopher Hass, Tanya Koropecyj-Cox, John Krigbaum, Hrishikesh Kumbhojkar, Lynn O’Sickey, Heidi Radunovich, Jennifer Rea, Vicki Sarajedini, Brenda Smith,

**Absent:** Elif Akcali, David Julian, Andrew Ogram, Mario Poceski, Alison Reynolds, Lisa Spiryda

**1. Minutes from the October 3<sup>rd</sup> meeting were approved.**

**2. Courses for Review:**

Course#	Title	Current GE & WR	Request	Decision
ENC 3453	Writing in the Health Professions	---	C, E6	Approve
ENC 3464	Writing in the Social Sciences	---	C, E6	Approve
ENC 3465	Writing in the Law	---	C, E6	Approve
GLY 3882C	Hydrology and Human Affairs	---	P	Recycle
REL 2174	Social Ethics/Religion	H	Recertification	Approve
ECO 2013	Principles of Macroeconomics	S	Recertification	Conditionally Approve
THE 2000	Theatre Appreciation	H, D	Recertification	----
MUL 2010	Introduction to Music Literature	H, N, E2	Review	----

**ENC3453:** *Writing in the Health Professions*, Approved. The committee suggested that the syllabus refrain from using abbreviations, such as “EBM” and “BA”, for clarity. The committee also suggested including a discussion of ethics in the schedule of topics.

**ENC3464:** *Writing in the Social Sciences*, Approved. The committee suggested including a discussion of ethics in the schedule of topics.

**ENC3465:** *Writing in the Law*, Approved. The committee suggested that the syllabus be more explicit regarding students submitting multiple drafts of assignments and receiving feedback.

**GLY3882C:** *Hydrology and Human Affairs*, Recycled. The committee expressed concern about the academic integrity of having all coursework un-proctored and collaborative. They suggested using a tool such as Turnitin for written work. Additionally, the syllabus needs to provide information on reading materials for each

module and clarify how critical thinking skills and hypothesis testing are addressed by activities in the course.

**REL2174:** *Social Ethics/Religion*, Approved. The course is approved for Humanities designation only. If Diversity designation is desired an application must be submitted to the committee.

**ECO2013:** *Principles of Macroeconomics*, Conditionally Approved. There is inconsistent information provided in the “Course Delivery” section of the syllabus regarding testing for online and in-class students. The section should be modified to explain that online students don’t sit for live exams and must instead use ProctorU. Additionally, the committee suggested that the course use graduate TAs as soon as it becomes possible to do so.

### **3. General Education Assessment**

The General Education Assessment subcommittee members are David Julian, Elayne Colon, Eva Czarnecka-Verner, Chris Hass, and Shannon Cochrane.

Due to time constraints THE2000 and MUL2010 were tabled.

Meeting adjourned at 10:00am.

## Spring 2015 GLY 3882C – Hydrology and Human Affairs

Dr. Liz Sreaton, [sreaton@ufl.edu](mailto:sreaton@ufl.edu) Office hours 11am to noon Monday and 10-11 Tuesday, or by appointment

**TA and office hours: TBA**

**Overall Course Goals and Outcomes:** Water is a resource that is vital for life, but the quality and quantity of our water resources are currently under threat. Students will understand the basic concepts of groundwater flow, and its relationship to surface water, humans, and the environment and apply concepts to current water-related issues. By the end of this course, students will be able to:

- Describe the basic concepts of groundwater flow and its relationship to surface water, humans, and the environment.
- Apply hydrologic methods, including potentiometric surface mapping, cross-section development, and data analysis, to assess water-related problems.
- Summarize, present, and discuss hydrologic information from scientific reports and the media.

**Class Format:** The class is online on Canvas and consists of 12 modules.

- Each module will begin with a background reading to introduce the concepts and terms.
- The reading will be followed by an online quiz, which consists of 10 T/F questions. Quizzes are open book and open notes and you can seek help from classmates.
- Assignments in each module will focus on reinforcing and applying the concepts from the reading. Assignments will involve working on maps or cross-sections, data interpretation and calculations, and virtual experiments. Assignments will be assessed using multiple-choice questions, essay questions, and evaluation of submitted maps, calculations, and cross sections. Assignments are open book and open notes and you can seek help from others, **but answers must be written in your own words and figures must be drawn by you.**
- Assignments will also examine current problems through discussions in student groups. The discussions will include student written posts and a total of 2 student audio/video presentations. Audio/video presentations will be reviewed by two peers and revised prior to presentation to the group. The written post or presentation will be evaluated on how well it addresses the question or assignment and the quality of written or oral communication. Discussion replies and peer reviews will be assessed on content, thoughtfulness, and quality of written communication. Three assignments will consist of individual written 1-page syntheses of discussions.
- Every 4 modules, there will be a quiz consisting of wrap-up questions (9 questions at 10 points each). You will have 90 minutes for completion. In these wrap-up quizzes, you will apply what you have learned and integrate material from different modules. The wrap-up questions are open book and open notes but **are to be completed on your own.** During the semester, the class modules build on previous learning. As a result, material from earlier modules will be included, although the emphasis of each set of wrap-up questions will be on the most recent 4 modules.
- **Academic Honor Code:** Students must follow the University of Florida Honor Code. On all work submitted for credit by students of the University of Florida, the following pledge is either required or implied: "*On my honor, I have neither given nor received unauthorized aid in doing this assignment.*"

Before submitting any work for this class, please read the policies about academic honesty at <http://www.dso.ufl.edu/sccr/honorcode.php>.

- Turnitin is an online service to help prevent and identify student plagiarism. The wrap-up quizzes and the synthesis assignment will be evaluated using Turnitin to determine the originality of your work.

**Textbook:** Due to the lack of an appropriate textbook, chapters have been written for each module. These readings are found linked from each module.

**Prerequisites:** one chemistry course (e.g. CHM 1030).

### **Grading 1000 total points.**

- **Introductory quiz and discussion = 20 pts**
- **11 quizzes @ 10 points = 110 points.** *Your best 11 quiz scores (out of 12) will be counted for your grade.*
- **Assignments: 12 modules @ 50 points/module = 600 points.**
- **3 sets of wrap-up questions @ 90 pts/each = 270 points.**

A: ≥934 pts, A- 900-934 pts; B+ 867 - 899 pts, B: 834 - 866 pts, B-: 800 t- 833 pts, C+ 767 - 799 points; C 734 - 766 pts, C-: 700 - 733 pts, D+: 667 t- 699 pts, D: 634 - 666 pts. D-600 - 633 pts; E 599 and below. **These grade criteria are firm.** (*Information on how UF calculates GPA based on letter grades can be found at: <https://catalog.ufl.edu/ugrad/current/regulations/info/grades.aspx> )*

**Physical Sciences Requirement:** Physical science courses provide instruction in the basic concepts, theories and terms of the scientific method in the context of the physical sciences. Courses focus on major scientific developments and their impacts on society, science and the environment, and the relevant processes that govern physical systems. Students will formulate empirically-testable hypotheses derived from the study of physical processes, apply logical reasoning skills through scientific criticism and argument, and apply techniques of discovery and critical thinking to evaluate outcomes of experiments.

To fulfill the physical science requirement, this course focuses on the major developments in the field of hydrology including the physical processes that govern groundwater flow and the chemical processes that affect water quality. These developments will be used to illustrate the scientific method. Critical thinking skills will be developed using virtual experiments and analyses of recent water-related issues. Students will evaluate data to formulate and test hypotheses. Some examples are described below:

- In Modules 2 to 4, students will a) formulate hypotheses concerning the causes of recent low discharge rates in springs of the Suwanee River, Florida and discuss how to test each hypothesis b) examine rainfall, river discharge records, and potentiometric surface maps to evaluate the hypotheses. Students will develop critical thinking skills by comparing the causes and consequences of water overuse in Florida and in the High Plains aquifer.
- In Module 6, students will use observations from a table-top aquifer model and Darcy's law to predict groundwater flow directions and travel times. The predictions will be tested using dye tracing in the model.
- In Module 5 and 6, students will develop hypotheses concerning the movement of contaminants at the Cabot-Koppers site in Gainesville and test these hypotheses using available drilling data



and Darcy's law. In Module 11, students will revisit their hypotheses in light of additional data provided by groundwater sampling.

- In Module 9, students will predict how water chemistry will evolve downstream along the Suwannee River. These hypotheses will be tested through evaluation of water sampling data at locations along the river.
- Throughout the semester, examples will be used to emphasize the need to question and test assumptions and hypotheses. These examples include a) a case study of groundwater contamination by arsenic in Bangladesh, where it was assumed that groundwater would be high quality; b) a study of how incorrect assumptions about travel times in the Wakulla springs region were altered by new data; and c) the case of the Vaiont landslide in Italy where it was assumed that a reservoir could be safely filled.

### **The General Education requirements for Student Learning Outcomes are:**

**Content:** Students demonstrate competence in the terminology, concepts, theories and methodologies used within the discipline.

**Communication:** Students communicate knowledge, ideas and reasoning clearly and effectively in written and oral forms appropriate to the discipline.

**Critical Thinking:** Students analyze information carefully and logically from multiple perspectives, using discipline-specific methods, and develop reasoned solutions to problems.

In this course, the *content outcome* will be assessed through the 12 quizzes based on terminology and concepts for each module, the assignments, and the 3 "Wrap-Up" Quizzes for each four modules. The *written communication outcome* will be assessed through your discussion posts, syntheses of discussions, and your answers on the "Wrap-Up" Quizzes. Discussion posts are evaluated for completeness and clarity. Discussion synthesis are assessed on content, organization, and mechanics. The *oral communication outcome* will be assessed through two audio/ video presentations, which will be assessed for content, use of supporting material, and delivery. *Critical thinking* will be assessed through the Discussion syntheses, which require you to integrate scientific understanding of hydrology with societal factors that affect water use, and the 3 "Wrap-Up" Quizzes, which will require you to apply concepts and methods to new situations.

**Getting answers to your questions:** This class is a 3000 level, which means it is aimed at junior-level students (although open to others). This means that you should be challenged by some parts of the material. Expect to have questions as you read the course notes, work through the assignments, and prepare for the wrap-up questions.

- For problems with Canvas: call 352-392-4357 or via e-mail at [helpdesk@ufl.edu](mailto:helpdesk@ufl.edu).
- To report course-specific errors (a broken link in an assignment, a suspected error in quiz grading, missing information in a quiz question) email the TA ([Imeridth@ufl.edu](mailto:Imeridth@ufl.edu)) and me ([screaton@ufl.edu](mailto:screaton@ufl.edu)). We will correct the problem as quickly as possible and credit you 1 point.
- For content questions, the first place to go is to Discussions and the Q&A for the module. If the question hasn't been asked yet, you can post your question to the class. Help your classmates by answering questions --- BUT **help by explaining rather than just giving the answer!** Answers will be reviewed by the TA/professor daily M-F and additional information may be added.

- An email to the TA and prof is the best way to ask questions that are specific to you, such as about your grade or an upcoming conflict.

### **Deadlines:**

- Modules are to be completed by **Wednesdays at 6 pm**. BUT, to allow for any last-minute technical issues, I strongly recommend you complete the assignments by Tuesday. Quiz (T/F) grades will be immediately available and assignment grades will generally be available by the end of Friday.
- Modules will generally be available 2 weeks prior to the deadline. An exception will be quiz 1, which will be available at the start of classes. I strongly recommend starting quizzes and assignments early enough to ask questions and get answers.
- The three wrap-up quizzes will become available the Friday after assignments are due for Modules 4, 8, and 12 and are due by the end of the following Monday.

**Attendance and conflicts:** Requirements for class attendance and make-up exams, assignments, and other work in this course are consistent with university policies that can be found in the online catalog at: <https://catalog.ufl.edu/ugrad/current/regulations/info/attendance.aspx>

Because quizzes and assignments are available for 1-2 weeks and wrap-up questions are available for several days, only very major conflicts will be considered to allow deadline extensions or make-ups. For *pre-existing conflicts* (e.g., athletic, religious, academic), **you are responsible** for providing me with email or written notification and making arrangements with me (screaton@ufl.edu) for an alternate date as soon as you are aware of the conflict, **but no later than 1 week before a deadline**. For *sudden, unexpected major issues that cause you to need additional time* **you are responsible** for providing me (screaton@ufl.edu) with email or written notification and making arrangements. Documentation will be requested.

**Accommodations for Disabilities:** Students with disabilities requesting accommodations should first register with the Disability Resource Center (352-392-8565, [www.dso.ufl.edu/drc/](http://www.dso.ufl.edu/drc/)) by providing appropriate documentation. Once registered, students will receive an accommodation letter which must be presented to the instructor when requesting accommodation. Students with disabilities should follow this procedure as early as possible in the semester.

**Course Evaluations:** Students are expected to provide feedback on the quality of instruction in this course by completing online evaluations at <http://evaluations.ufl.edu>. Evaluations are typically open during the last two or three weeks of the semester, but students will be given specific times when they are open. Summary results of these assessments are available to students at <https://evaluations.ufl.edu/results>

## Course Modules

### **Introduction:** *Must be completed before starting Module 1*

- Introductory quiz
- Introductions Discussion

### **Module 1: Fundamentals of Groundwater** *Due Jan 14*

- Reading: Chapter 1 describes the hydrologic cycle, how water is stored and flows underground, and the relationship between geologic materials and water flow and storage.
- Quiz 1 Fundamentals
- Assignment 1.1 High Plains aquifer discussion
- Assignment 1.2 Porosity and storage
- Assignment 1.3 Creating and Interpreting Hydrogeologic Cross Sections
- Assignment 1.4 High Plains aquifer and depletion calculation

### **Module 2: Wells and Potentiometric Surface Maps** *Due Jan 21*

- Reading: Chapter 2 describes how wells are installed and how water levels from wells can be contoured and interpreted to understand groundwater flow directions.
- Quiz 2 Wells and Potentiometric Surface Maps
- Assignment 2.1 Florida Springs discussion
- Assignment 2.2 Drawing Potentiometric Maps
- Assignment 2.3 Interpreting potentiometric surface maps

### **Module 3: Groundwater inflow and Outflow** *Due Jan 28*

- Reading: Chapter 3 introduces water budgets and describes how precipitation, evapotranspiration, and groundwater recharge and discharge are quantified.
- Quiz 3 Groundwater Inflow and outflow
- Assignment 3.1 Precipitation, Evapotranspiration, and Recharge in the High Plains and Florida
- Assignment 3.2 Using potentiometric surface maps to predict groundwater- surface water exchange
- Assignment 3.3 The High Plains and Florida Spring synthesis

### **Module 4: Streams and Floods** *Due Feb 4*

- Reading: Chapter 4 describes how stream flow is measured and how stream flow and how groundwater flow are connected.
- Quiz 4 Streams and Floods
- Assignment 4.1 Stream Discharge and Hydrographs
- Assignment 4.2 Flood recurrence intervals
- Assignment 4.3 Water Decisions Discussion

### Module 1 to 4 Review and Wrap-Up Quiz *Due Feb 11*

### **Module 5: Florida Hydrogeology and Geology and Groundwater** *Due Feb 18*

- Reading: Chapter 5 describes Florida's hydrogeology as an example of how geology influences groundwater flow.
- Quiz 5: Florida and Geology and Groundwater
- Assignment 5.1 Florida hydrogeology

- Assignment 5.2 Gainesville hydrogeology and the Cabot-Koppers site
- Assignment 5.3 Aquifer Examples Presentation Drafts

**Module 6: Darcy's Law** *Due Feb 25*

- Reading: Chapter 6 introduces Darcy's Law, which describes groundwater flow.
- Quiz 6 Darcy's Law
- Assignment 6.1 Darcy's experiment to Darcy's Law
- Assignment 6.2 Applying Darcy's law
- Assignment 6.3 Aquifer Examples Presentation Peer Review

**Module 7: Pumping and Groundwater Budgets** *Due Mar 11*

- Reading: Chapter 7 describes how an aquifer's inflows and outflows are impacted by the addition of pumping and under what circumstances pumping can lead to subsidence of the land surface.
- Quiz 7 Pumping and Groundwater Budgets
- Assignment 7.1 Water budgets and subsidence
- Assignment 7.2 California drought, water use, and subsidence
- Assignment 7.3 Aquifer Examples Presentations and Discussion

**Module 8: Water Management and Law** *Due Mar 18*

- Reading: Chapter 8 introduces the basics of surface and groundwater law in the U.S., and summarizes strategies for management of water resources.
- Quiz 8 Water Management and Law
- Assignment 8.1 Surface water and groundwater law
- Assignment 8.2 Dams and water management
- Assignment 8.3 Aquifer Examples Synthesis

**Modules 5 to 8 Review and Wrap-Up Quiz** *Due Mar 25*

**Module 9: Water Chemistry** *Apr 1*

- Reading: Chapter 9 describes the basics of the reactions that affect the chemistry of surface and ground water.
- Quiz 9 Water Chemistry
- Assignment 9.1 Sampling and water chemistry: Examples from the Suwannee River basin
- Assignment 9.2 Arsenic in Bangladesh groundwater
- Assignment 9.3 Water Chemistry and Contamination Presentation Drafts

**Module 10: Water Quality** *Due Apr 8*

- Reading: Chapter 10 further examines water quality, focusing on nutrients and eutrophication and saltwater intrusion.
- Quiz 10 Water Quality
- Assignment 10.1 Freshwater/Saltwater Interface
- Assignment 10.2 Water quality
- Assignment 10.3 Water Chemistry and Contamination Presentation Peer Reviews

**Module 11: Water Contamination** *Due Apr 15*

- Reading: Chapter 11 describes sources of water contamination, how contaminants migrate in groundwater, and basics of contamination remediation.
- Quiz 11 Water Contamination
- Assignment 11.1 Water contamination
- Assignment 11.2 Water Chemistry and Contamination Presentations and Discussion

**Module 12: Karst and Sinkholes** *Due Apr 22*

- Reading: Chapter 12 relates water chemistry to formation of caves and sinkholes in limestone and other soluble rocks and discusses the implications for water and contaminant migration.
- Quiz 12 Karst and Sinkholes
- Assignment 12.1 How caves and sinkholes form
- Assignment 12.2 Tallahassee sprayfields and nitrates at Wakulla Springs
- Assignment 12.3 Water Chemistry and Contamination syntheses

**Module 9 to 12 Review and Wrap up Quiz** *Due Apr 29*

## Chapter 1 Fundamentals

### The hydrologic cycle

When rain falls (or snow melts in northern areas), some of the water **runs off** to streams and some of the water returns to the atmosphere through **evaporation**. The remaining water can seep downward, or **infiltrate**, into the ground. Where plants exist, they can pull in the infiltrated water and then **transpire** the water vapor to the atmosphere.

### HYDROLOGIC CYCLE

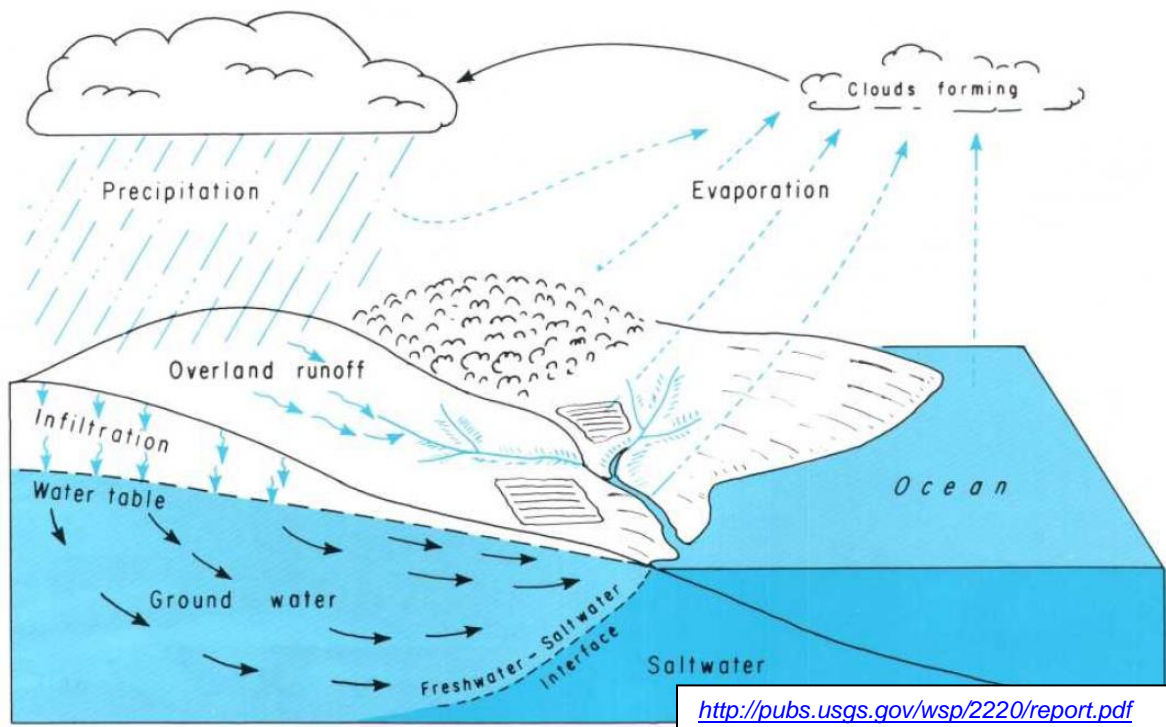

Gravity pulls water downward through the **unsaturated zone** (shown in white on the figure) where the pores contain both air and water. Eventually, the water reaches the **saturated zone** (shown in light blue), where the pores are completely filled with water. The **water table** is approximately at the boundary between the unsaturated and saturated zones.

The infiltrating water that is not removed by transpiration **recharges** the groundwater beneath the water table. Groundwater flows from where the water table is higher to where it is lower. Days to thousands of years after water enters the aquifer as recharge,

groundwater **discharges** back to streams, lakes, and the ocean or is pumped out of the ground by people.

At the present time, most of Earth's water (97.5 %) is saltwater, most of which is stored in the oceans (<http://water.usgs.gov/edu/earthwherewater.html>). It is not suitable for most human uses without desalinization (removal of the salt). Of the 2.5% of earth's water that is fresh, most is stored in glaciers and other ice (1.7%), some is as groundwater (0.7%), and a small fraction is stored as surface water (0.03% of Earth's water).

### Water withdrawals and use

Water withdrawals from surface or groundwater are primarily for agriculture (70%), followed by industry (19%) and municipal use (11%). When water is withdrawn, it can be returned to the source (**non-consumptive use**) or be transferred to the atmosphere by evaporation or discharged to the oceans, which is termed **consumptive use**.

The linked figures compare consumptive and non-consumptive uses, as well as show trends through time (<http://www.unep.org/dewa/vitalwater/jpg/0211-withdrawcons-sector-EN.jpg>). Factors in the change through time are population growth and per capita use as countries become more developed ([http://www.fao.org/nr/water/aquastat/globalmaps/World-Map.wv.cap\\_eng.htm](http://www.fao.org/nr/water/aquastat/globalmaps/World-Map.wv.cap_eng.htm)).

Surface water is generally easier to access than groundwater but may be less reliable due to seasonal changes or droughts. It can also be more vulnerable to human-caused contamination. Statistics from the U.S. Geological Survey (USGS) indicate that surface water provides 77% of the freshwater withdrawals and groundwater provides 23% (<http://water.usgs.gov/edu/wugw.html>). Keep in mind, however, that surface water and groundwater are linked in the hydrologic cycle. Streams that keep flowing year-round, even when there has not been recent rainfall or snowmelt, usually gain their water from groundwater.

### Where is water stored underground?

There are spaces between the grains of sediment or the mineral crystals in rocks. These voids are called pores, and porosity is the volume of voids per total volume of sediment or rock.

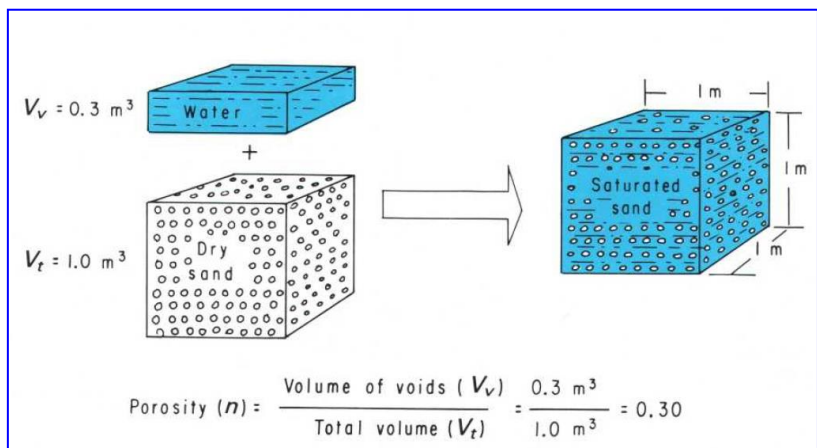

<http://pubs.usgs.gov/wsp/2220/report.pdf>

Example: If a cubic meter ( $\text{m}^3$ ) of sand has  $0.7 \text{ m}^3$  of sand grains and  $0.3 \text{ m}^3$  of water, the porosity is  $0.3/1.0$  or  $0.3$ .

**Primary porosity** is the original space between the grains of sediment remaining from when the sediments were deposited. As sediments become more deeply buried, those spaces are reduced. Cements (minerals precipitated from water) can also help to reduce the primary porosity.

**Secondary porosity** consists of new voids created after the rock was formed. Rocks may fracture due to unloading (removal of overlying weight by erosion), or due to stresses created by the movement of earth's tectonic plates. Caves and other openings can be created in some rock types (such as limestone) when flowing water dissolves minerals.

Not all pore spaces are connected. Some pore spaces can be isolated in the rock, and water cannot enter. **Effective porosity**,  $n_e$ , is the ratio of the volume of interconnected porosity to the total volume of the rock.

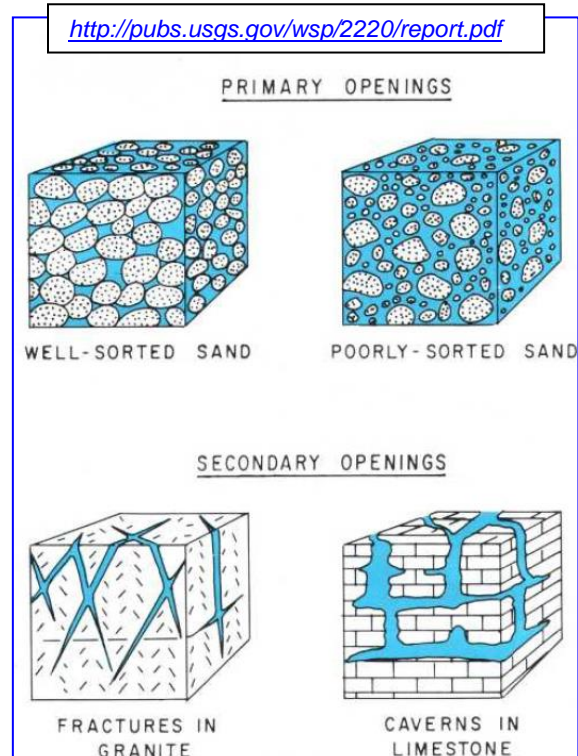

**Permeability** ( $k$ ) is the ability of a rock or sediment to conduct fluid. The higher the permeability, the faster water can move through the rock. The most important controls on permeability are how large the pore spaces are and how well connected the pores are. Larger pore spaces mean that there is less friction to slow down flow. Well-connected pore spaces mean that the water does not get stuck in dead-ends or have to take long, windy paths to travel through a rock.

**Hydraulic conductivity** ( $K$ ) combines permeability ( $k$ ) and the viscosity and density of the fluid. Viscosity of a fluid is its internal resistance to movement. For example, oil has a higher viscosity than water. As a result, it will have a lower hydraulic conductivity and will tend to move more slowly. A denser fluid will tend to move more quickly than a less dense fluid.



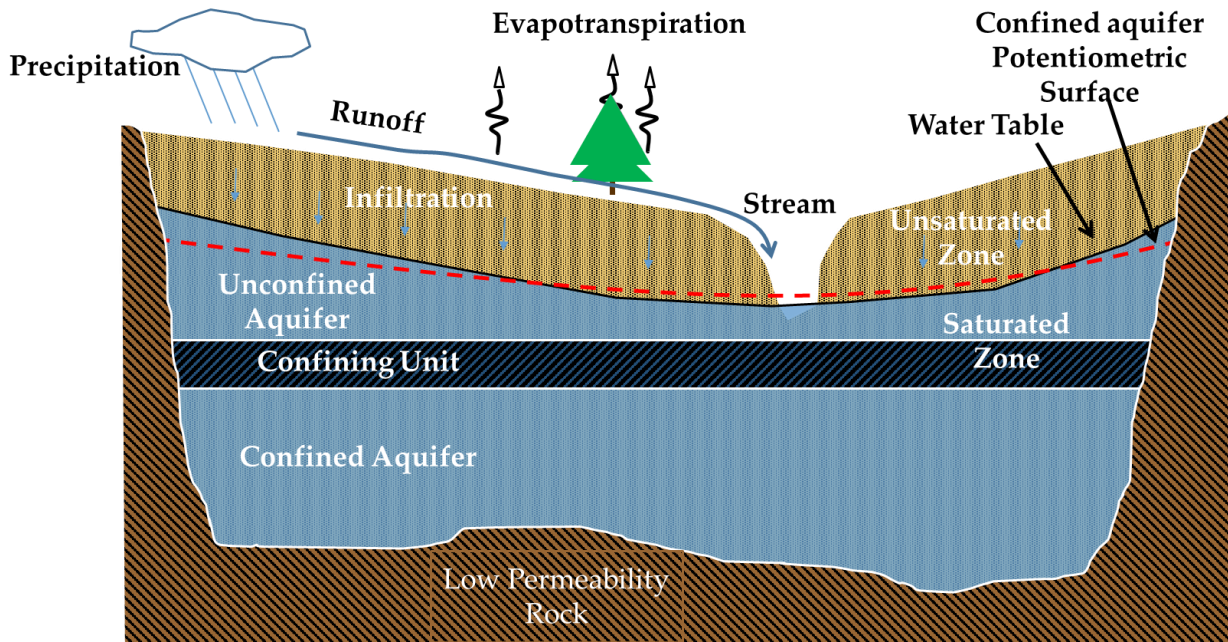

## Aquifers and Confining Units

An **aquifer** is a geologic unit which stores and transmits usable quantities of water, and a **confining unit** (sometimes called an **aquitard**) consists of material with low hydraulic conductivity.

If there is not a confining bed above an aquifer, it is called **unconfined**, or sometimes termed a **water-table aquifer**, because its upper boundary is the water table. The water table will rise and fall depending on the balance between the rates of recharge and discharge. As a result, the saturated thickness of the unconfined aquifer will change through time. If recharge is greater than discharge, the water table will rise. If discharge exceeds recharge, the water table will drop. Water is stored in an unconfined aquifer by filling or emptying pore spaces. The amount of water that can be stored in an unconfined aquifer per change in height of the water table is called the **specific yield**. When the water table falls, not all of the water in the pore spaces drains downward to the water table. Some remains clinging to the aquifer solids. As a result, the specific yield, is always less than the porosity.

If there is a confining unit above an aquifer, the only way that additional water can be stored is by increasing the water pressure and expanding the aquifer (pushing the mineral grains apart). Removing water reduces the water pressures and causes the aquifer to compress. This type of aquifer is **confined** or **artesian**. If a well is drilled into the aquifer, its pressure will cause the water in the well to rise above the top of the aquifer. The height that water would rise up to (if it could) is shown by the dashed line labeled **confined aquifer potentiometric surface**. In some cases, the potentiometric

surface is above the ground surface (such as in the streambed above). If a well is drilled into a confined aquifer where the potentiometric surface is above the land surface, water will flow out onto the ground, creating a **flowing artesian well**.

In the figure above, water can only reach the confined aquifer by slowly travelling downward through the confining unit. Because the confining unit has low hydraulic conductivity, this travel can take years to many centuries. Fully confined aquifers often have very old water and very low rates of recharge. Groundwater leaves the confined aquifer by travelling slowly up through the confining bed to the stream.

### Geology and Groundwater

Geology is very important to groundwater flow, because the rock type and its history affect the size, shape, and interconnection of the pore spaces. These characteristics control the rock's permeability and the hydraulic conductivity (see the table which shows porosity and the hydraulic conductivity for water at 20°C).

### Igneous and Metamorphic Rocks

Intrusive igneous rocks and metamorphic rocks form at great depths (miles) beneath the earth's surface where high pressures cause the mineral crystals to grow together closely. Examples of intrusive igneous rocks include granite, andesite, and gabbro, and examples of metamorphic rocks include slate, schist, and gneiss. As a result of their formation at great depths, pore spaces are very small and primary porosity is very low. Hydraulic conductivity will be very low unless fracturing has created secondary porosity. Because the pore spaces created by fractures are relatively straight and interconnected, fractures can greatly increase hydraulic conductivity.

Fractured igneous or metamorphic rock can act as an aquifer, while unfractured igneous/metamorphic rock often are confining units.

**Basalt** is one of the only igneous rocks that commonly forms large important aquifers. Basalt is an extrusive igneous rock that forms when very low-viscosity lava flows onto the earth's surface (on land or beneath the oceans) and quickly cools. Over time, volcanic eruptions can build many layers of basalt flows, with repeated layers of low

Material	Porosity	Hydraulic Conductivity (m/s)
Gravel	0.2-0.4	$10^{-4}$ to $10^{-2}$
Sand	0.3 to 0.5	$10^{-7}$ to $10^{-3}$
Silt	0.3 to 0.6	$10^{-9}$ to $10^{-5}$
Clay	0.3 to 0.6	$10^{-11}$ to $10^{-9}$
Glacial Till	0.1 to 0.4	$10^{-12}$ to $10^{-6}$
Sandstone	0.05 to 0.3	$10^{-10}$ to $10^{-5}$
Siltstone	0.2 to 0.4	$10^{-11}$ to $10^{-8}$
Limestone/Dolostone	<0.01 to 0.4	$10^{-9}$ to $10^{-2}$
Shale/Mudstone	<0.01 to 0.1	$10^{-13}$ to $10^{-9}$
Evaporites	0.005 to 0.05	$10^{-12}$ to $10^{-8}$
Basalt	0.03 to 0.35	$10^{-11}$ to $10^{-2}$
Unfractured intrusive igneous or metamorphic rocks	<0.01 to 0.05	$10^{-14}$ to $10^{-10}$
Fractured intrusive igneous or metamorphic rocks	<0.01 to 0.10	$10^{-8}$ to $10^{-4}$

hydraulic conductivity (in the center of flows) and high hydraulic conductivity (at the tops of flows). The video link shows a Hawaiian basalt flow in which you can see how irregular the surface is: <http://www.bigislandvideonews.com/2011/09/23/video-scientists-film-fast-new-hawaii-lava-flow-from-ground/>

When another flow covers the irregular surface, it doesn't fill all the holes. As a result, primary porosity with large and well-connected pore spaces can exist at the tops of flows and hydraulic conductivity is very high.

Other types of volcanoes create smaller areas of lava flows (so usually aren't large enough to form important aquifers) and erupt ash. In terms of hydrogeology, rocks formed from ash falls (called tuffs) often act similarly to sand or silt deposits. However, if the ash is still hot when it lands, it can weld the tuff together, resulting in very low porosity and hydraulic conductivity.

## **Sedimentary Rocks**

Thick layers of **chemical sedimentary rocks** called **evaporites** formed in the past when shallow seas dried up and minerals **precipitated** as the water evaporated. Common minerals in evaporites include **halite** (salt, NaCl) as well as **gypsum** (hydrated calcium sulfate,  $\text{CaSO}_4 \cdot 2(\text{H}_2\text{O})$ ) and anhydrite ( $\text{CaSO}_4$ ). These rocks have very low primary porosity, because the crystals grow closely together. As a result, their hydraulic conductivity is low and evaporites can form confining units. Because gypsum and halite are soluble in water, evaporite deposits can affect the quality of water that has travelled through it, resulting in a salty taste or a sulfurous taste/smell. In addition, some evaporite deposits can have caves caused by **dissolution** (removal of the mineral by water). This secondary porosity can create large hydraulic conductivities. Regions or aquifers that have a lot of dissolution are termed **karst**.

For groundwater, the most important **biologic sedimentary rocks** are **limestone**, made of the mineral calcite (or calcium carbonate;  $\text{CaCO}_3$ ) and **dolostone**, made of the mineral dolomite (where magnesium replaces some of the calcium in limestone). Both limestone and dolostone are formed by organisms and are termed **carbonate** rocks. These organisms can range in size from microscopic plankton to large organisms such as clams and corals. The primary porosity of limestone and dolostone depends on how deeply they have been buried in the past. Like other sediments, burial can lead to compaction which reduces porosity. As the chart shows, carbonate rocks (such as limestone and dolostone) can have a very high hydraulic conductivity. This is generally due to dissolution, where slightly acidic groundwater removes minerals and creates secondary porosity. Karst aquifers are common in limestone and dolomite.

**Clastic sediments** and sedimentary rocks are made from the broken pieces of other rocks. These have been eroded, transported by mass movement, glaciers, wind, or water, and then deposited. The method of transport and deposition has a large effect on the hydraulic conductivity. Glaciers and mass movements deposit very **poorly sorted** sediments, consisting of a large range of grain sizes. In this case, the small grains fill the spaces between the larger grains. As a result, pore spaces are small and and poorly

connected, and poorly sorted sediments can have low hydraulic conductivity. For example, **glacial till** consists of sediments deposited by glacial ice. Till contains grain sizes ranging from boulders to clay-sized because the ice drops all these sediment sizes as it retreats. Often the till has been compacted by the weight of the glacier, lowering porosity and hydraulic conductivity further.

Both wind and water do a good job of sorting sediments. The higher its velocity, the larger size material the wind or water can carry. For example, as a stream slows down when it reaches a lake or the ocean, the largest sediments (gravel) will drop to the bottom first, then sand-sized material, then silt-sized, and then clay-sized material. Well-sorted gravel is deposited in stream channels and on high-energy beaches. Sands are also found in stream beds, in many beaches and in the nearshore marine environments, and deposited by the wind in dunes. Fine-grained sediments are deposited in low energy water, such as in lakes, the deep ocean, swamps, and floodplains (after the flood has passed). Wind can also deposit fine-grained silts (loess).

Well-sorted sand or gravel forms excellent aquifers because of their large, well-connected pores. In contrast, clay-sized material has extremely small pores. As water tries to move through these small pores, friction against the grains acts to dissipate energy and slow the flow. As a result, clayey sediments have very low hydraulic conductivities, and form confining units. Silts have slightly larger pores than clays (but smaller than sands), so are on the borderline between a confining unit and aquifer.

As sediments are buried by additional sediment being deposited above them, the sediment grains become more closely-packed. This **compaction** reduces the pore size and hydraulic conductivity. Crystallization of minerals such as calcite or quartz forms cements in the pore spaces can further reduce hydraulic conductivity. Compaction and cementation together are called **lithification** (or **consolidation**) and will eventually turn the sediments into sedimentary rocks. Gravels become *conglomerates*. Sands become **sandstones**. Lithified silt can be called either *siltstone* or *mudstone*, and lithified clay is called either *mudstone*, *claystone*, or *shale*. Semi-consolidated sands and gravels can form excellent aquifers. Highly lithified sandstones may require secondary porosity (fractures) to be good aquifers.

### **Aquifer heterogeneity and anisotropy**

If an aquifer has uniform hydraulic conductivity, it is termed **homogeneous**. An example of a homogeneous aquifer would be a sand formed at the beach. The sand is similar in size wherever you look, and would result in homogeneous hydraulic conductivity. In contrast, a karst aquifer would be **heterogeneous**: hydraulic conductivity is extremely high in caves and much lower in the surrounding rock.

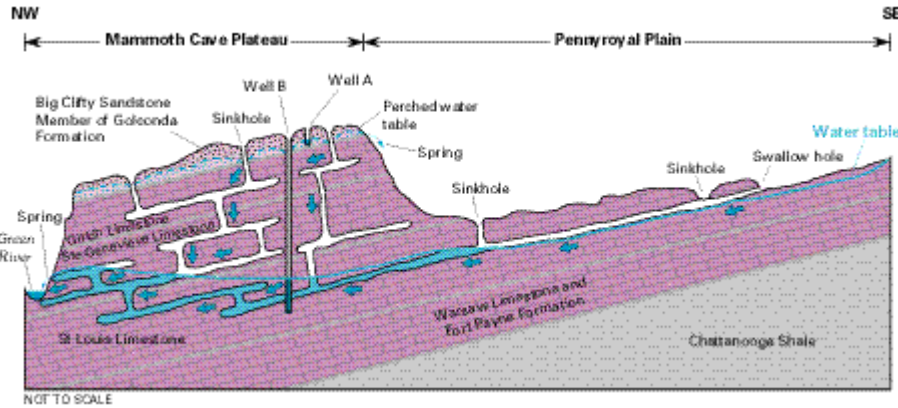

Karst aquifer (in purple) in the Mammoth Caves National Park region of Kentucky.  
[http://pubs.usgs.gov/h/a/ha730/ch\\_a/gif/A038.gif](http://pubs.usgs.gov/h/a/ha730/ch_a/gif/A038.gif)

In addition to varying with location, hydraulic conductivity can also vary with direction of flow. For example, if fractures are lined up in a certain direction, hydraulic conductivity will be higher in that direction than other directions. In sediments that are layered, it is easier for water to flow along the layers than across the layers. Hydraulic conductivity that is the same in all directions are **isotropic**, and hydraulic conductivity that varies with direction is **anisotropic**. The figure to the right shows an example of anisotropy due to fractures. Hydraulic conductivity will be higher parallel to the fractures and low perpendicular to the fractures.



<http://geology.er.usgs.gov/eespteam/Greatfalls/>

## Chapter 2 Potentiometric Surface Maps

Wells are very important for pumping groundwater and for measuring the height of the water table or potentiometric surface. The height that water will rise in a well is called the **hydraulic head**. *Groundwater will always try to flow from higher to lower hydraulic head.*

In the past, wells were constructed by digging by hand, and they were often as simple as a hole in the ground that was used to collect water. The holes would sometimes be lined with tiles or bricks to prevent it from collapsing. Wells can also be driven into the ground by pushing a small diameter pipe (with openings at the bottom end) into the ground. This method of well installation is limited to shallow, unconsolidated sediments. For deeper wells or for rock, drilling is used. Drilling methods include augers, rotary drilling that circulates mud, and sonic drilling, which uses high-frequency sound waves to create the borehole.

<http://pubs.usgs.gov/wri/wri964233/pdf/wri964233.pdf>

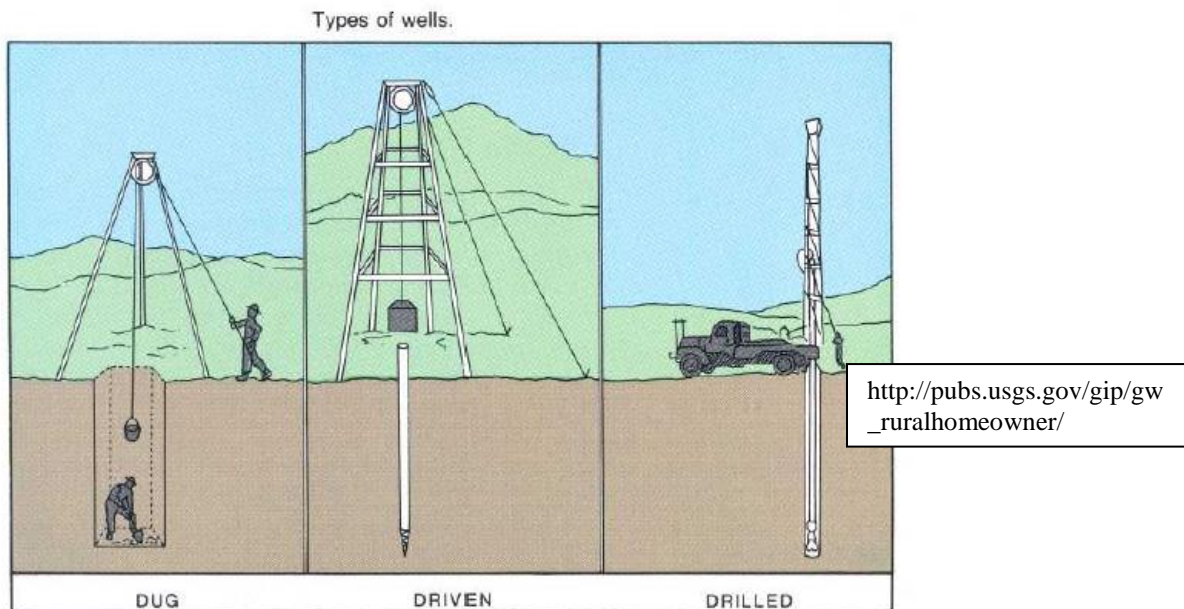

During drilling, geologic information is collected by either examining the drill cuttings (broken up pieces of the soil or rock) as they come to the surface or collecting **core** samples from inside the drill pipe.

### Well completion

After the hole is made by drilling or digging, **casing** is usually lowered into the borehole to prevent it from collapsing. Casing consists of PVC or steel pipe and can range in diameter from 2 inches to several feet. A large diameter is most common for large capacity water-supply wells. The casing will have holes or slots at the depth where it will collect water from the surrounding rock or

sediment. This casing with holes is called **well screen**. The holes are designed to be as small as possible to keep sediment out but not obstruct the water flow. If sediment enters a well it can fill up the well and also can damage the pump.

Sand or gravel is added to the hole surrounding the well screen to form a **filter pack**. This is intended to filter out sediment. In other words, silt and clay will get stuck in the pores of the filter pack rather than entering the well.

It is very important that runoff from the surface cannot enter the well and contaminate the aquifer. Therefore, a **borehole seal**, such as cement or clay, is added to the hole outside the casing above the filter pack. In the figure, the well cap sticks up above the land surface. In high-traffic areas, the top of the well can be below the surface.

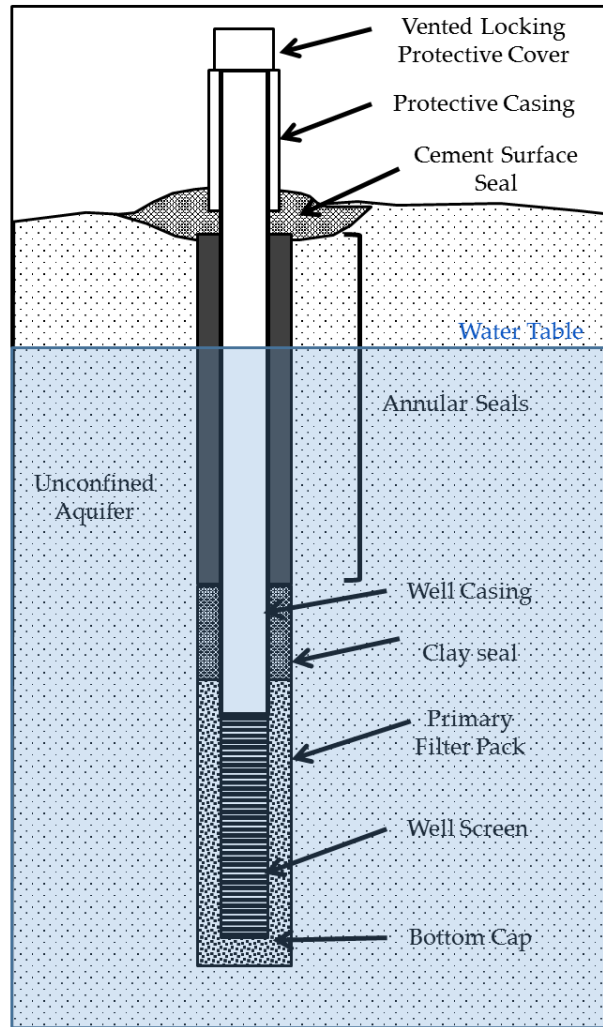

When installing a well into a confined aquifer, it is vital to avoid connecting aquifers across confining layers. If aquifers are cross-connected, artesian aquifers could lose pressure by flowing into other aquifers or contamination could move between aquifers.

Where contamination is an issue, drilling of deep wells into confined aquifers requires several stages: 1) drill to the top of the confining layer. 2) install casing and seal the hole around it. Clean all drilling equipment. 3) with a smaller drill bit, drill through the confining layer and install the well screen and filter pack in the confined aquifer 4) seal above the filter pack.

The final step in preparing a well for use is called **well development**, in which mud from the drilling and fine material is removed from the well, the well screen, the filter pack, and the aquifer near the screen. This is done by repeatedly bailing or pumping the sediment-filled water from the well, and then allowing the well to

recover. This creates movement back and forth through the screen and helps to clean out fine-grained sediment. After a well is installed, a pump might be installed in the well to provide a water supply. Wells are also used for collecting samples to measure water quality.

An additional use of a well is for monitoring hydraulic head. The depth to water can be measured by lowering a measuring tape that has an electronic sensor that makes a sound when it reaches the water. Hydraulic head is calculated by subtracting the depth to water from the elevation of the top of the well.

### Mapping groundwater flow

Because groundwater flows from higher hydraulic head to lower hydraulic head, maps of the water table or **potentiometric surface** map can help predict groundwater flow directions. The wells used for the map should all be from the same aquifer. Ideally, the hydraulic heads should be measured over a short period of time during which the water-table (or potentiometric surface) is stable. After hydraulic head is determined at each well (step **A**), the values can be contoured (step **B**). During contouring, contours of equal hydraulic head (also called **equipotential** lines) are drawn by interpolating between the well hydraulic heads (for example, the 140 foot contour would lie half way in between a well that has a head of 145 ft and one that has a head of 135 feet).

**If an aquifer is isotropic, flow lines will be perpendicular to equipotential lines (Step C).** Because the equipotential lines curve, the flow lines will also curve so that they meet the equipotential lines at a 90° angle.

A potentiometric surface map for an unconfined aquifer is often called a “water table map”. It shows you the elevation at which you will encounter water if you dig or drill.

In contrast to the water table of an unconfined aquifer, the potentiometric surface of a confined aquifer is an imaginary surface. It connects the height of water within wells in the confined aquifer. You would not reach the water until you drill through the confining layer. Once you have drilled through the confining layer, the water in the confined aquifer will rise in the borehole due to its pressure.

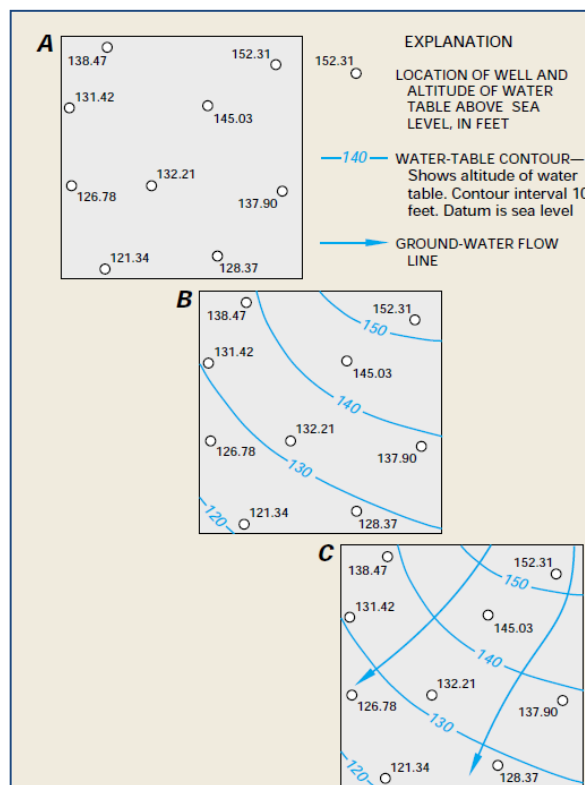



In unconfined aquifers, surface water is connected to groundwater. In other words, nothing prevents water from flowing from aquifer to surface water or vice versa. Surface water elevations should be measured and used to help create the water-table map. The figure below shows the contours “v” upstream at the rivers. If you were to draw flowlines, they would show flow into the river. The other surface water in the map is the ocean, which has an elevation of 0 m above sea level.

Another common feature in potentiometric surface maps is a **groundwater divide**. Groundwater can only flow from higher to lower hydraulic head. It cannot flow to higher hydraulic heads or to an equal hydraulic head. That means that between the two 40 m contours on the figure below there must be a high point in the water table. To the north of the groundwater divide, flow will go north, and to the south, flow will go to the Rivers and the ocean. Groundwater contours in unconfined aquifers sometimes are similar to the overlying topography, but not always. As a result, groundwater divides are not always the same as surface water divides.

On the left side of the map, there is a closed depression, with a zero m contour inside a 10 m contour. That means that groundwater will flow into the depression from all sides. This is usually caused by a pumping well and is called a **cone of depression**.

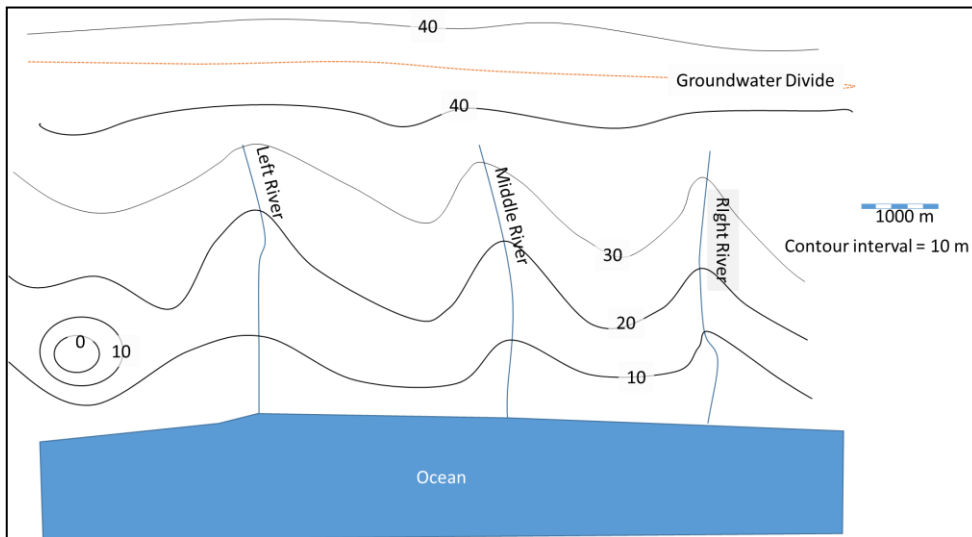

While unconfined aquifers are usually closely connected to surface water, it is less common for confined aquifers. As a result, surface water elevations should only be added to a confined aquifer's potentiometric surface maps if a connection is known to exist. For example, a very deep river might cut through a confining layer and be connected to a confined aquifer.

## Chapter 3 Groundwater in the Hydrologic Cycle: Inflows and Outflows

A common problem facing users of aquifers is overuse. The **water budget (or water balance) equation** states that:

$$\text{Inflow-Outflow} = \text{Change in Storage}$$

Before development, many aquifers are at a **steady state**, which means that inputs and outputs balance and there is no change in storage. There will be seasonal changes and cycles of high precipitation and droughts, but over the long-term (decades) recharge will balance outflow and the water table will remain relatively stable. Pumping adds a new outflow. Unless recharge increases --such as from humans adding water to the aquifer-- or other forms of discharge-- such as groundwater flow to streams or the ocean --decrease, water storage will decrease. As a result, the hydraulic head will decrease. In unconfined aquifers, the water table will drop, and in confined aquifers, the water pressure will decrease.

To understand how to use an aquifer sustainably, it is very important to know its water budget. One important component is how much recharge it receives. Only a portion of precipitation reaches the water table to recharge aquifers. For example, in Florida less than 1/3<sup>rd</sup> of the rainfall recharges the aquifer. The remainder evaporates, is transpired by plants, or becomes runoff which flows to surface water.

### **Recharge = precipitation - runoff - ET**

This section provides more information about precipitation, runoff, and ET, and how they are quantified. *Unless otherwise noted, material and figures are from Healy et al (2007), which can be found at [http://pubs.usgs.gov/circ/2007/1308/pdf/C1308\\_508.pdf](http://pubs.usgs.gov/circ/2007/1308/pdf/C1308_508.pdf)*

### **Precipitation**

Precipitation carries water from the atmosphere to the earth's surface, and can be rain, snow, dew, or fog drip. A **rain gage** accumulates water and is manually read like a graduated cylinder. Readings can also be automated through automatically weighing the sample. The weights can be stored by a data logger. Another common type is the tipping bucket rain gage. The rainfall fills up the bucket to a pre-set volume, which causes the bucket to tip and empty. Each time the bucket tips, it is recorded.

Snowfall can be measured using an automated weighing device, or with a tipping bucket that has a heater to melt the snow. Difficulties in measuring snow occur due to wind moving the snow after it has fallen. To check on this, surveys of snow depths are conducted.

**Doppler radar** can provide rainfall distribution over a large area. The radar sends out energy. If that energy encounters water droplets (or ice or snow), it is scattered and some of the energy is returned. By measuring the returned energy, the intensity of precipitation can be estimated (see <http://weather.noaa.gov/radar/radinfo/radinfo.html> for more information). Because a number of factors can affect the energy return, ground-truthing with rain gages is still necessary.

Precipitation can (1) be stored on the surface, (2) evaporate, (3) run off, or (4) infiltrate. With the exception of glaciers and ice fields, surface storage is generally short term (a season or less). Snow and ice are the most common form of surface storage, but liquid water can be stored in depressions on the surface and rainfall or snow can be intercepted by plant leaves.

**Infiltration** is affected by the hydraulic conductivity of the soil. The higher the hydraulic conductivity, the more quickly water can infiltrate. Infiltration rates tend to decrease with rainfall, as initially dry soil can store some of the water until pore spaces fill. Infiltration capacity can be measured using an **infiltrometer**, in which water is added to the land surface (in the ring in the photo on the right) and the rate of water flowing into the soil is monitored.



*Infiltrometer.*

During extended or heavy precipitation events, the infiltration capacity of the soil can be exceeded. Water will pond at the surface, filling shallow depressions. Once the depressions are filled, water begins to move downhill as **runoff** towards streams, lakes, or the ocean. The ratio of runoff to infiltration depends on the soil's infiltration capacity and the rate of precipitation. It is also affected by the steepness of the drainage basin, and the vegetation. The steeper a drainage basin is, the faster water flows overland, providing less time for infiltration. Vegetation can slow down overland flow, increasing time for infiltration. Vegetation can also have indirect effects on runoff, as it intercepts water on its leaves or transpires water to the atmosphere. Runoff begins as sheet flow and then focuses into channelized flow in streams. *We will return to stream flow and flooding in a later class.*

**Evapotranspiration** includes evaporation and transpiration. Both transfer water from the liquid to gas phase. Evaporation is the direct transfer from surface water to the atmosphere, whereas transpiration is enabled by plants. Evaporation rates depend on available water, solar radiation (because evaporation uses energy), and the water content of the air (higher humidity lowers evaporation rates). Evaporation measurements from surface water are made using a

**land pan**. This metal pan (picture to right from [srh.noaa.gov](http://srh.noaa.gov)) is filled with water and the loss of water is monitored. Because the metal sides warm in the sun and increase evaporation, pan evaporation rates have to be corrected by multiplying by a pan factor (or pan coefficient) which generally ranges between 0.58 and 0.78.



**Evapotranspiration (ET)** incorporates both direct evaporation of water and transpiration by plants. ET can be measured by detailed monitoring of wind speed and its water content to determine how much water is being transported. Because evapotranspiration requires energy, ET can be determined by monitoring all energy sources and sinks to (to calculate the heat removal due to evaporation. Another field method to determine ET uses experimental plots where all inflow of water and all other outflow (besides ET) are measured. ET is then calculated using a water budget.

ET is difficult to measure, and it is often more common to use estimates based on conditions. **Potential evapotranspiration** is the amount that would be lost if there were an unlimited supply of water. PET can be calculated using data solar radiation, humidity, temperature, and wind speed. This calculation can be used to estimate how much irrigation is needed for agriculture or landscaping. In natural environments, actual evapotranspiration is generally less than the potential evapotranspiration. Although there are some plants (called phreatophytes) that extend their roots into the saturated zone and pump out water, most plants have shallow root systems and can only access water stored in the upper several feet of the unsaturated zone. If moisture in the root zone becomes very low the surface tension prevents roots from pulling in the water. As a result, plants will transpire less water. If conditions become extreme, the plants will die. On the other hand, if enough infiltration occurs to exceed the storage capacity in the root zone the water will continue downwards to the water table and become recharge.

## Groundwater and Surface Water

Groundwater in unconfined aquifers is closely connected to surface water. Surface water can be recharged from surface water and/or it can provide water (discharge) to surface water. The information and figures on groundwater and surface water are from USGS Circular 1139, Ground Water and Surface Water: A Single Resource (Winter et al, 1998) (<http://pubs.usgs.gov/circ/circ1139/pdf/circ1139.pdf>).

## Streams

Runoff supplies water to streams for a few days to several weeks after rainfall or snowmelt. In between runoff events, groundwater discharge, or **baseflow**, sustains the flow. This prevents the stream from drying up and allows stable ecosystems. A **gaining stream** receives groundwater. The water table is higher than the adjacent stream and water flows from the aquifer to the stream. A **losing stream** has water levels higher than the surrounding aquifer, and stream water flows into the aquifer. You can determine whether groundwater flows into the stream or stream water flows into the aquifer by drawing flowlines on the water-table map.

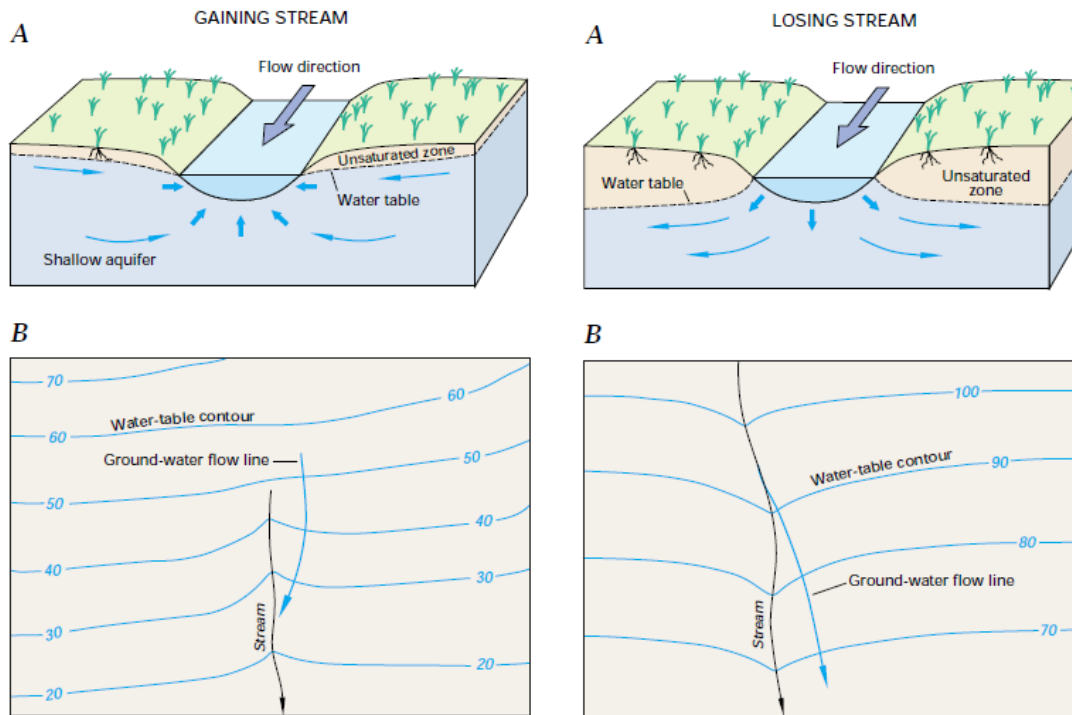

The relationship between a stream and the surrounding aquifer determines whether streamflow is continuous throughout the year (perennial streams), only flows for weeks or months when the water table is high, or receives no baseflow and only flows for hours or days after rainfall (ephemeral streams). Groundwater flow also helps to stabilize the water temperature (because groundwater temperatures fluctuate less than surface water

temperatures). In a later class, we'll also consider differences in water chemistry between surface and groundwater.

## Springs

Springs are locations of focused groundwater discharge. Springs can discharge water from both unconfined and confined aquifers. Springs occur for a number of reasons:

- a depression in the land surface can focus groundwater discharge. *In the figure to the right, springs will occur at the location marked "seepage face", into the stream at the bottom of the valley, and in the flood plain.*
- A boundary between an aquifer and an aquitard can help to focus the discharge. Water will have an easier time flowing laterally along the aquifer rather than flowing into the aquitard. In the picture to the right, a spring occurs where the confined sand aquifer intersects the surface water. The lines on the figure are equipotential lines and the arrows show flow path moving perpendicular to the equipotential lines. Equipotential lines bend (or **refract**) at the contact between the silt and the sand due to the contrast in hydraulic conductivity. Refraction occurs because it is easier for the water to flow through the sand, and it will tend to follow the sand layer horizontally. Because equipotential lines and flow lines are perpendicular to each other (for isotropic hydraulic conductivity), the equipotential lines must become more vertical.
- Dissolution can create cave systems that allow rapid groundwater flow. Most springs in the Floridan aquifer system and due to underground cave systems.

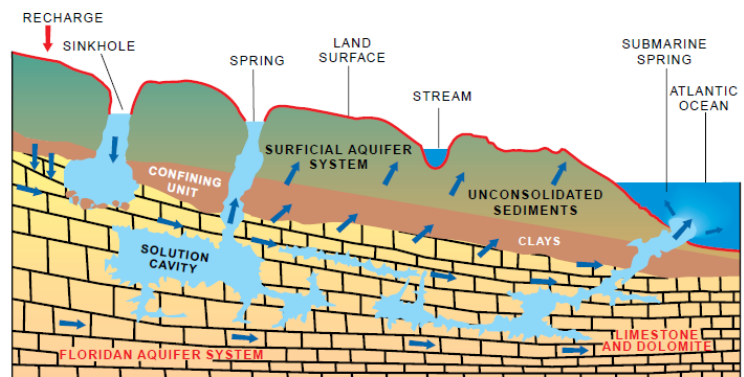
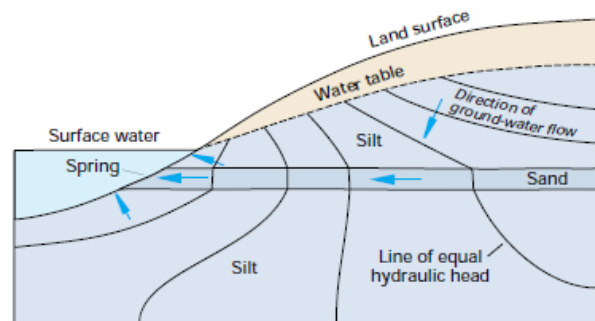
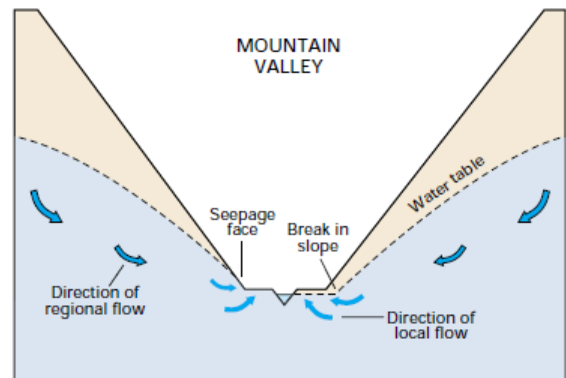

EXPLANATION  
 → DIRECTION OF GROUND-WATER FLOW

[http://fl.water.usgs.gov/PDF\\_files/fs151\\_95\\_spechler.pdf](http://fl.water.usgs.gov/PDF_files/fs151_95_spechler.pdf)

- Faults and fractures can also provide high hydraulic conductivity and allow rapid groundwater discharge.

**Hot springs** form when groundwater flows up from depth faster than it can cool down. Temperature increases with depth into the earth, and can be particularly high where there is subsurface magma (such as beneath Yellowstone National Park or Hawaii).

Spring water is sold as having special properties or being very pure, but is actually no different than the surrounding groundwater. In fact, bottled spring water in the U.S. does not need to come from the spring itself, just the same underground formation that supplies a spring. Requirements on water quality testing of spring water are variable, but often less stringent than for municipal water supplies.

Springs provides source water to lakes, wetlands, and streams, as well as human water supplies. In addition, springs provide scenic and recreational value. Protecting springs considers not only the spring itself but the recharge area for the spring. This area is termed the **springshed** or capture area of the spring. A springshed can be determined by creating a detailed potentiometric surface map and then tracing flow directions to determine which flow lines go to the spring.

## Lakes

In terms of groundwater, lakes can be either A) **discharge lakes**, where groundwater flows into the lake and is lost to surface water or evapotranspiration; B) **recharge lakes**, where surface water flows into the lake and then recharges the groundwater; or C) **flow through lakes**, where groundwater flows into and out of the lake.

Drawing equipotential lines and flowlines helps to show whether a lake is discharging the aquifer, recharging the aquifer, or is a flow-through lake.

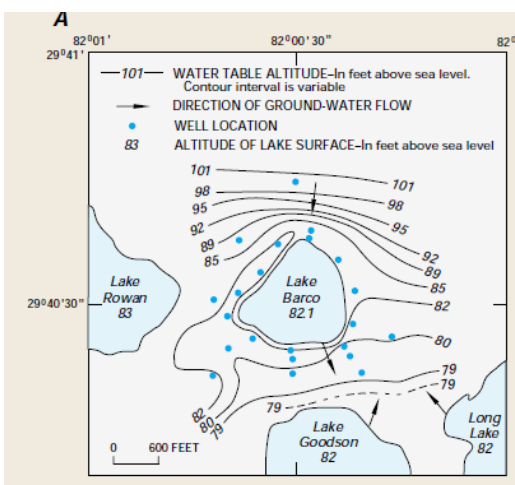

The water-table map to the left shows that Lake Barco in Florida is a flow-through lake. Groundwater enters in the north and lake water flows into the aquifer on the south side.

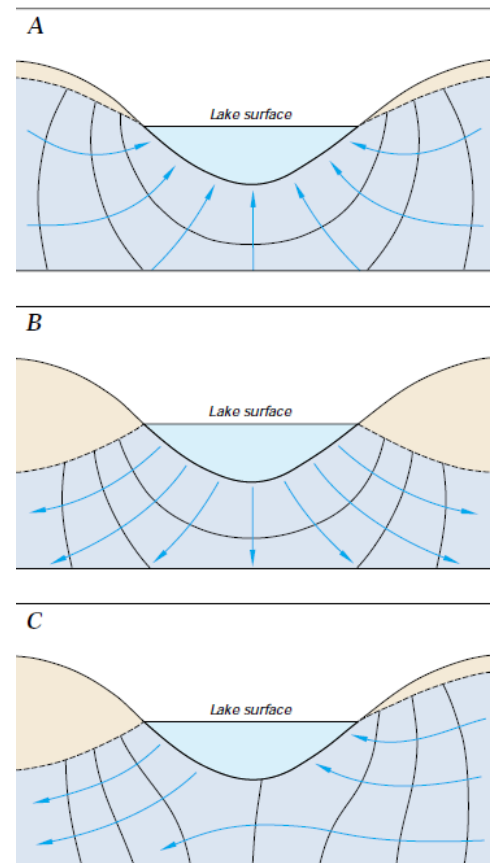

Figure 16. Lakes can receive ground-water inflow (A), lose water as seepage to ground water (B), or both

Lakes have some important differences from streams. 1) Due to their larger storage volume (compare to streams), natural lakes tend to have more stable water levels. 2) Residence times of water in lakes are much longer than in streams, also due to the larger water volume. 3) The larger surface area means that evaporation can cause a significant loss of water. 4) Due to slow velocities of surface water in lakes, fine-grained material and organic matter can settle to the bottom, forming a low hydraulic conductivity layer that can slow exchange between the lake and groundwater.

## Wetlands

The U.S. legal definition of wetlands (from epa.gov) is: "those areas that are inundated or saturated by surface or groundwater at a frequency and duration sufficient to support, and that under normal circumstances do support, a prevalence of vegetation typically adapted for life in saturated soil conditions." The main differences between other surface water (streams/lakes) and wetlands are the dominance of vegetation and that wetlands can be dry for portions of the year (although streams and lakes can be also).

Wetlands include swamps, marshes, bogs, and fens. Like lakes, **wetlands** can receive groundwater (C to the right), recharge groundwater (D) or a combination of recharge and discharge.

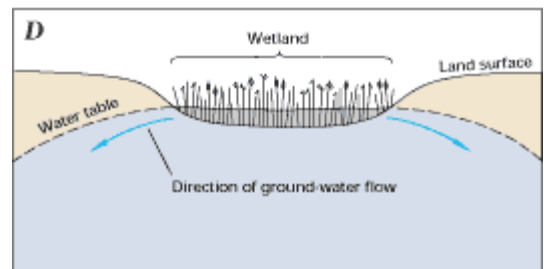
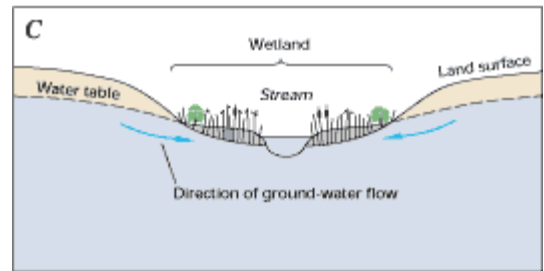

An important historical difference between lakes and wetlands is that lakes have generally been valued (for recreation and scenery) whereas the value of wetlands has not been recognized until recently. Wetlands were considered a waste of land and have been drained for development and agriculture. Drainage for agriculture is estimated to be responsible for >80% of wetlands loss in the U.S. Acreage of wetlands lost in the U.S. is shown to the right.

More recently, some of the value of wetlands has become known. Wetlands perform important functions, including aquifer recharge, floodwater storage, erosion control, ecosystems, support of fish, shellfish, timber and other commercial products.

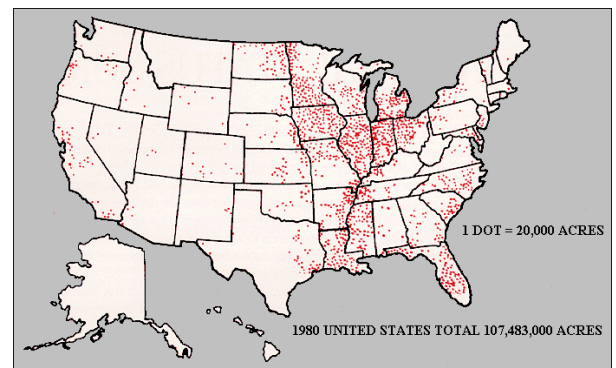

<http://www.npwrc.usgs.gov/resource/wetlands/wetloss/figure5.htm>



## Chapter 4 Streams and Floods

Two important measurements in a stream at a particular location are its water level, which is called its **stage**, and its **discharge**, which is the volume of water flowing past a point in a given time. Stream discharge ( $Q$ ) is measured by determining the velocity ( $v$ ) and cross-sectional area of the stream ( $A$ ). Velocity is usually measured with a current meter. Because velocity and depth vary across the stream, discharge measurements are conducted by

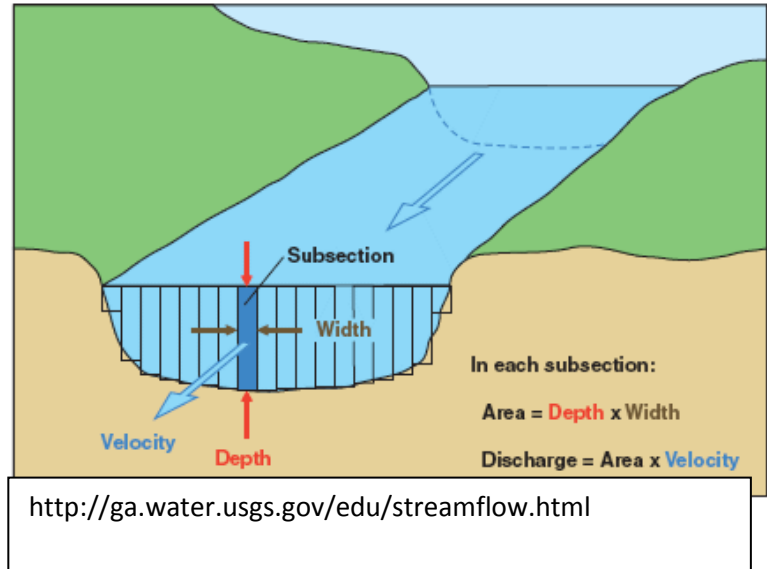

breaking the stream into subsections. Velocity and depth are measured within each subsection. Discharge of each subsection is calculated ( $Q=vA$ ), and all of the subsection discharge values are summed. (If you'd like more background on stream measurements or to see photos of current meters, <http://pubs.usgs.gov/fs/2005/3131/FS2005-3131.pdf>. This also has information on a new method, called an acoustic Doppler flow meter).

It would be very labor-intensive to measure discharge every day on every major stream.

Luckily, there is a short-cut. A **rating curve (or stage-discharge relation)** can be developed for the stream. This allows discharge to be estimated from a stage measurement. Stage is much simpler to measure than discharge. To create a rating curve, discharge must be measured at a variety of stream stages. These values are plotted, and a best-fit equation found for discharge as a function of stage. The figure to the right shows a rating curve for the Santa

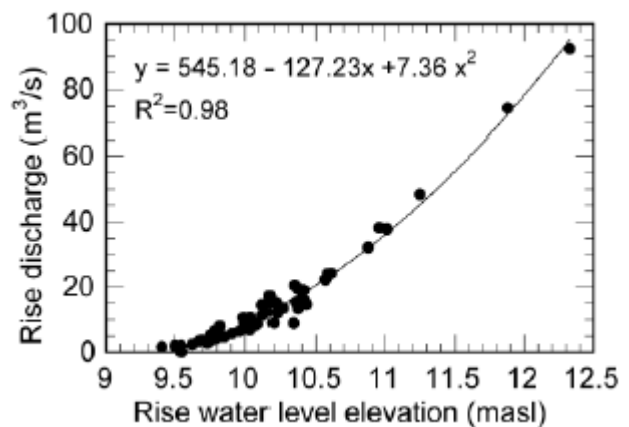

Fe River at River Rise State Preserve in Florida. Each of the dots represents a discharge measurement. After the rating curve is developed, discharge can be calculated for any stage. Stage is then manually read from a staff gage (a "ruler" that is permanently installed in the stream), or recorded from a sensor that measures the water level.

There are some important cautions about rating curves: There are often very few data points at extremely high flows because it is difficult – and sometimes dangerous -- to measure discharge during a flood. Another caution is that if the shape of the stream channel changes

due to deposition or erosion, new stage-discharge data must be obtained and a new rating curve developed.

Plots of river stage or discharge as a function of time, or **hydrographs** can be obtained from the U.S. Geological Survey for many rivers in the U.S (water.usgs.gov). For example, below is a hydrograph from 2012 for the Frio River in Texas. This is a stream that has no groundwater baseflow. As a result, it only flows after large storms, making it an **ephemeral** stream. The discharge quickly disappears as it flows downstream and infiltrates into the ground.

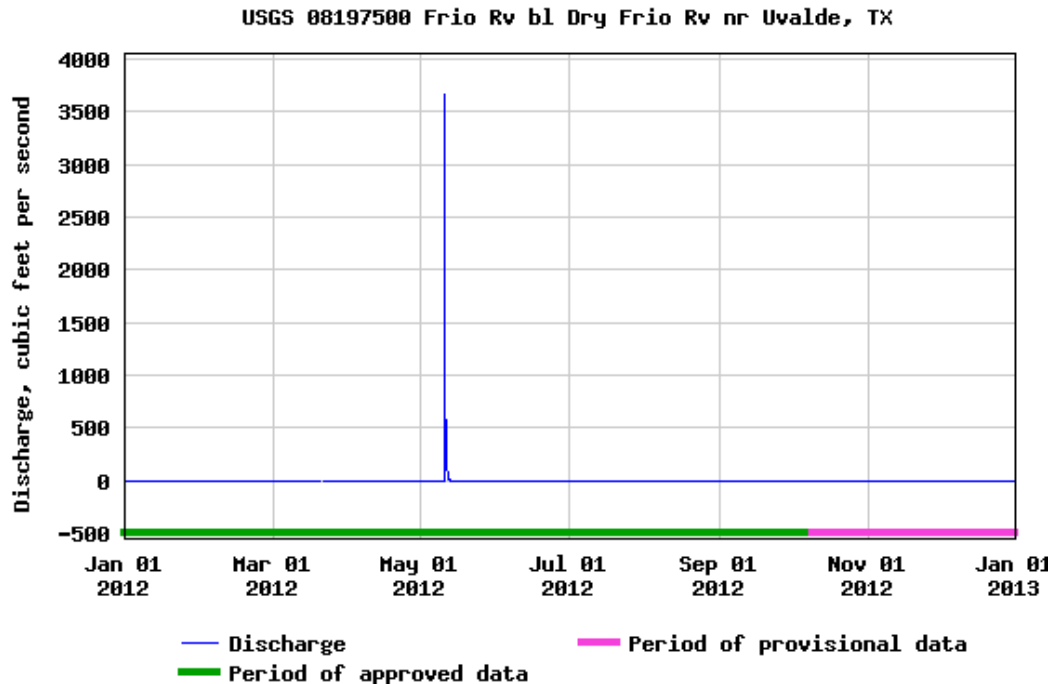

The Suwannee River discharge hydrograph on the next page is typical of many perennial streams. Baseflow provides water to the Suwannee River throughout most of the year. After storms, stream discharge rapidly increases due to runoff (for example, in March 2012 and in late June 2012). At the same time, the aquifer is recharged by infiltration during the storm event. The recharge increases the aquifer's hydraulic head. Bank storage can occur if the stream water level becomes higher than the aquifer's water level. After the flood peak has passed, baseflow re-starts. Unless new runoff or recharge occurs, there will be a **baseflow recession** (such as in April 2012 or Oct-Nov 2012) because the aquifer's hydraulic head slowly decreases as the amount of stored groundwater decreases. According to Darcy's law, as the hydraulic gradient between the aquifer and the stream decreases, groundwater discharge to the stream will decrease. This pattern results in asymmetric peaks in hydrographs. The rising limb is very steep due to runoff occurring rapidly after precipitation. In contrast, the falling limb is much more gradual because water is released slowly from groundwater storage as baseflow.

Stream discharge measurements often provide valuable information about groundwater flow rates and budgets. For example, the Ichetucknee River in Florida is almost entirely fed by springs and groundwater inflow (no runoff). So measuring the river's discharge provides information on groundwater

discharge rates. In the Suwannee River, the calculations are more complicated, because it is necessary to separate the runoff from baseflow to determine groundwater flow rates. You can also think about a “reach” of a river between two gaging stations (locations where discharge is measured). By examining the differences in discharge at the two stations (and correcting for any runoff or streams that enter), you can calculate the amount of groundwater baseflow. An important caution is that the USGS estimates that there is 5 to 10% error in discharge measurements (higher during flood peaks), so this will add uncertainty to baseflow estimates.

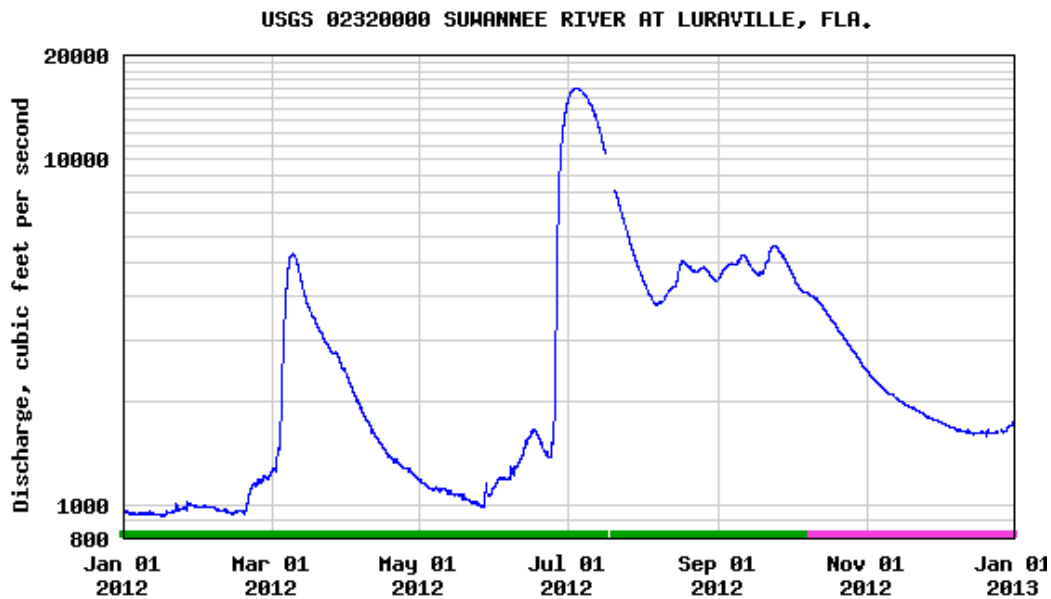

## Floods

**Floods** occur when the stream stage is high enough that a river overflows its banks. Flood waters can carry away property, erode land, inundate houses and other buildings, and leave behind silt and mud. **Floodplains** are lands bordering rivers and streams that normally are dry but are covered with water during floods. Floodplains provide valuable water storage during floods and can help to decrease downstream flooding.

During floods, water can also be temporarily stored in unconfined aquifers. When rainfall occurs, runoff may increase the water level in the stream faster than recharge raises the water table. As a result, water temporarily flows from the stream into the

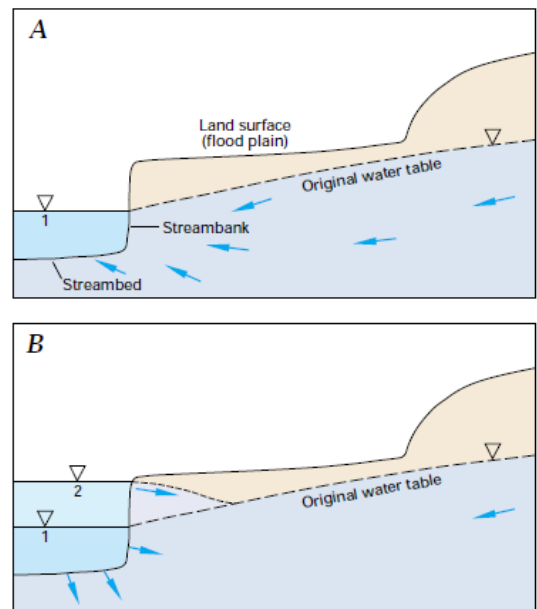

stream banks. This **bank storage** returns to the stream after the stream's water level drops. Bank storage is important because it helps to reduce the size of flood peaks by temporarily storing water. Channelizing streams, particularly with concrete or other impermeable material, prevents storage of water in the stream's floodplain and banks.

The most dangerous floods are those that occur very rapidly and with little warning. These **flash floods** are most common with steep drainage basins, little vegetation to slow down runoff, and low soil permeability.

Short-term flood prediction relies on continuous monitoring of streams (such as by the USGS), and accurate measurement of precipitation (such as by rain gauges and Doppler radar). The amount of runoff is controlled by infiltration, so it depends on vegetation, prior conditions (e.g., whether previous rainfall has saturated the soil), permeability of surface material, and the steepness of the drainage basin. Flood prediction also involves modeling how the flood peak will move down the stream and how water is stored in the adjacent floodplain and aquifer.

Over the long-term, a commonly used method of flood planning is to examine the past occurrence of floods to determine the future probability of a certain flood size. The **recurrence interval** of a certain size flood reflects how likely it is to occur. For planning purposes, the **"100-year flood"** is often used for zoning regulations and for insurance purposes. This is the flood discharge that has a probability of 1 chance in 100 of occurring in a particular year. The name "100 year flood" has caused the misunderstanding that a flood of that size can only occur once every 100 years. There can be (and have been) "100-year floods" in 2 consecutive years.

Most streams have limited discharge records, a lot of uncertainty exists in the estimated sizes of 100 or 500-year floods. Furthermore, climate patterns change through time (as we saw with rainfall records for the Suwannee River) and infiltration and runoff will change as a drainage basin becomes urbanized. These changes can greatly affect flood frequency.

## Chapter 5 Florida Hydrogeology and the Geology of Groundwater

**For more information:** US Geological Survey Aquifer Basics

(<http://water.usgs.gov/ogw/aquiferbasics/>) and the Groundwater Atlas of the U.S

([http://pubs.usgs.gov/ha/ha730/ch\\_a/index.html](http://pubs.usgs.gov/ha/ha730/ch_a/index.html)). For more information on Florida geology, visit the Florida Geological Survey (<http://purl.fcla.edu/fcla/dl/UF00000124.pdf>)

### Florida Geology and Hydrogeology

Thousands of feet below the surface, Florida has a “basement” of igneous, metamorphic, and sedimentary rocks that were added to North America when Pangaea formed (>200 million years ago). Following the break-up of Pangaea, the large platform on which Florida sits was covered with shallow seas in which organisms deposited thick carbonate rocks in tropical seas during the Jurassic to Miocene; 200 Million years ago (Ma) to 25 Ma. These rocks are limestone and dolostone. In addition to the limestone and dolostone, there are also some evaporites that formed on tidal flats. These evaporites contain gypsum ( $\text{CaSO}_4 \cdot 2(\text{H}_2\text{O})$ ) and anhydrite ( $\text{CaSO}_4$ ).

Sequence of Aquifers

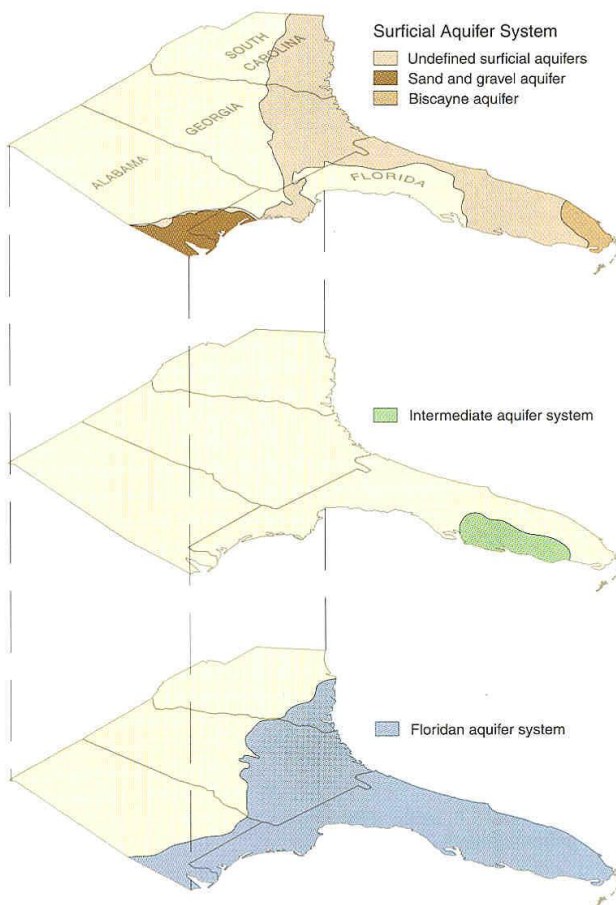

The upper portion of this thick sequence of carbonates forms the **Floridan aquifer system**. The Floridan aquifer system is separated into the upper and lower Floridan aquifer where lower hydraulic conductivity rocks, often dolostones or evaporites, form confining layers within the carbonates.

The upper Floridan aquifer is the major source of water in Central and North Florida, including Gainesville. It is a carbonate aquifer that has never been deeply buried. As a result, it has a high primary porosity. In many locations dissolution has formed cave systems and

other signs of karst topography. In south Florida, the water in the Floridan aquifer system is too salty for use. This is thought to be naturally occurring saltwater.

While the carbonates and evaporates of the Floridan aquifer system were forming, the Appalachians were eroding. Rivers carried sand, silt, and clay to the coast, but it did not reach Florida until 25 Ma. A deep channel or strong current swept away the sediment (the Suwannee Strait in the figure on the previous page). Eventually the clastic sediments started to fill the seas, making conditions difficult for the organisms that formed the carbonate. Sands, silts, and clays eventually covered the platform and are called the **Hawthorn Group**.

Silts and clays within the Hawthorn Group form a confining layer above the upper Floridan aquifer. Limestone layers within the Hawthorn group form the **Intermediate aquifer**, which is an important water source in Southwest Florida. The intermediate aquifer is mostly confined, and the aquifer is not exposed at the surface at all.

Aquifers in Southwest Florida

[http://www.swfwmd.state.fl.us/publications/files/flas\\_aquifers.pdf](http://www.swfwmd.state.fl.us/publications/files/flas_aquifers.pdf)

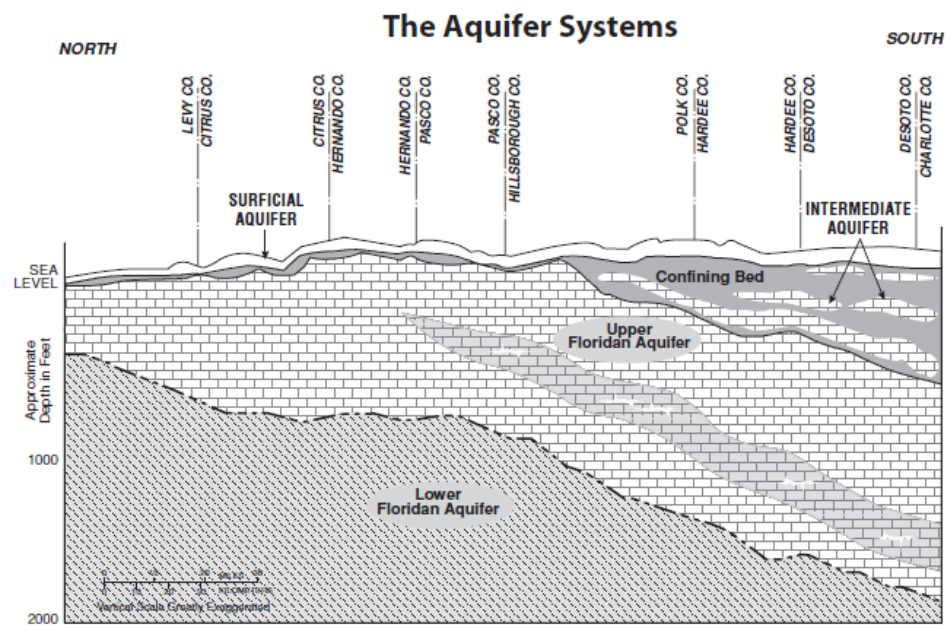

In the blue areas on the map to the right, the Hawthorn group has been eroded away. In these areas, the upper Floridan aquifer is unconfined.

Above the Hawthorn Group, younger sands were deposited. There are also some young carbonate deposits, particularly in South Florida. Coral reefs still exist offshore the southeast coast of Florida today. These sands and young carbonates

above the Hawthorn Group form the **Surficial aquifer system**. In most of the state, it consists of sand and gravel under unconfined conditions and is not a major water supply. It is mostly used for households, lawns, and irrigation.

There are two places where the surficial aquifer system is important. In these areas, the surficial aquifers get their own names. In NW Florida cities such as Pensacola, the **Sand and Gravel** aquifer is a primary water supply. It is primarily unconfined, but can be locally confined.

In South Florida, the **Biscayne aquifer** is a 60 to 200 foot-thick, young limestone and sandy **limestone aquifer**. It supplies water to the Miami and Fort Lauderdale area. The Biscayne aquifer is unconfined and groundwater is not separated from surface water of the Florida Everglades.

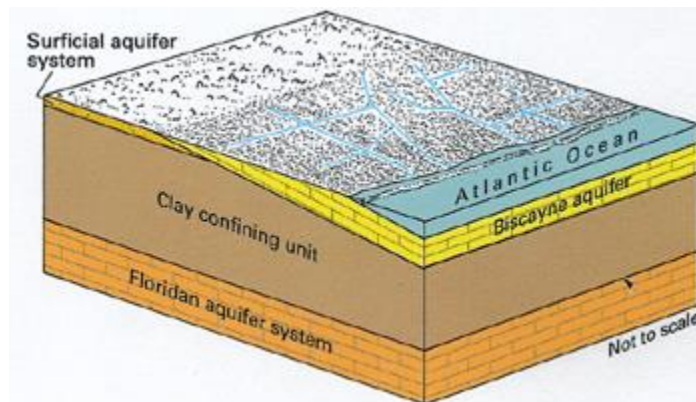
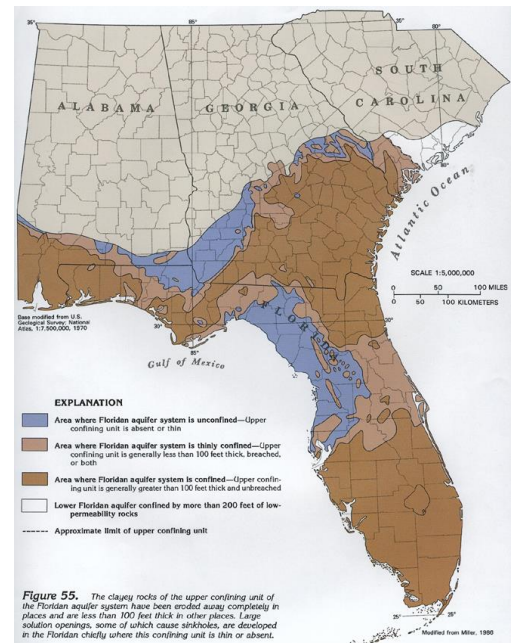

## Geology and Groundwater

**Unconsolidated sand and gravel aquifers** (blue on the map) have not been buried, so are not very compacted or cemented. Many sand and gravel aquifers consist of alluvial deposits, meaning that they were deposited by rivers. Streams can deposit coarse sediments in the channels and silt and clay on floodplains. As a result, alluvial aquifers can be heterogeneous, and sometimes the aquifer is locally confined by clays.

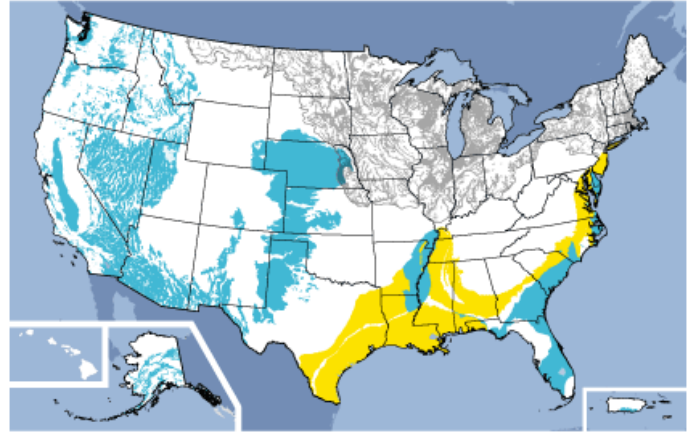

The **High Plains aquifer system** consists of a blanket of alluvial deposits that extend from South Dakota to Texas.

Glacial deposits can also create aquifers. Glacial till, which is deposited by glacial ice, generally forms confining layers. On the other hand, **outwash** (deposits from glacial melt water streams) can be productive aquifers. Glacially-deposited aquifers generally fill valleys that were eroded by the glaciers. The Woburn Massachusetts aquifer is an example. It consists of sand and gravel from glacial outwash and river deposits.

Glacial aquifers supply water to many towns in the northern U.S., but are not shown on a map because they tend to be small in size.

**Semiconsolidated sand and gravel aquifer systems** (yellow on the map above) consist of very thick deposits of alluvial and shallow marine sediments. In the U.S. these are most important along the East Coast and the Gulf Coast. These aquifer systems often have layers of sand and gravel (yellow) deposited when sea levels dropped and the oceans retreated and silts and clays (tan) deposited when the ocean level rose and covered more of the continents. Because the land surface generally slopes from onland to offshore, the aquifers generally dip and thicken from onshore to offshore. As a result, the aquifer system consists of several aquifers. The uppermost is unconfined and lower aquifer are mostly confined. Due to the large thickness of sediments, the sediments have begun to compact under the weight of the overlying sediments (but are not sufficiently consolidated to be considered

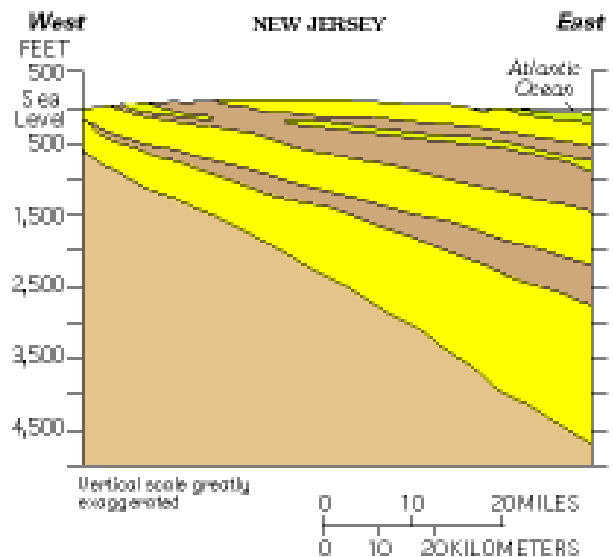



sandstone).

Important **sandstone aquifers** (in green on the map) were formed by river and coastal processes. These aquifers are generally older than those in unconsolidated or semiconsolidated aquifers and have been buried and lithified. The compaction and cementation has greatly reduced primary porosity and the hydraulic conductivity relative to semi- and unconsolidated sand and gravel aquifers. Secondary porosity from fractures is very important for allowing high hydraulic conductivities.

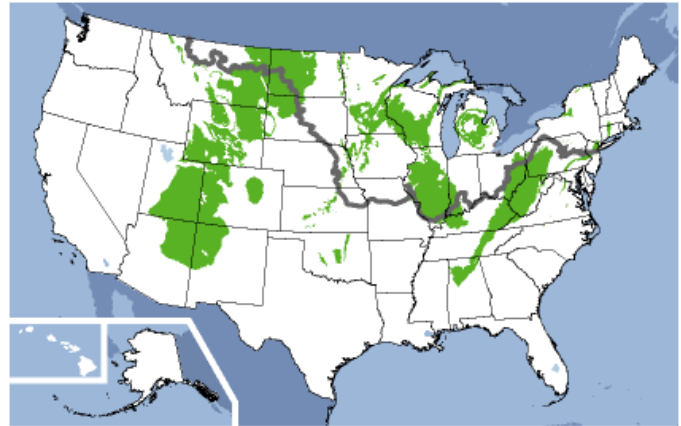

The most important **igneous aquifers** are located within **basalt**. Flow is primarily along the permeable tops of flows or in sediments that have been trapped in between flows. Igneous intrusions, such as dikes, are low-permeability and can block flow. U.S. locations with major basalt aquifers are the in the Pacific Northwest and in Hawaii. In other igneous and metamorphic rock aquifers, such as in the Appalachian Mountains, flow and storage are primarily within fractures.

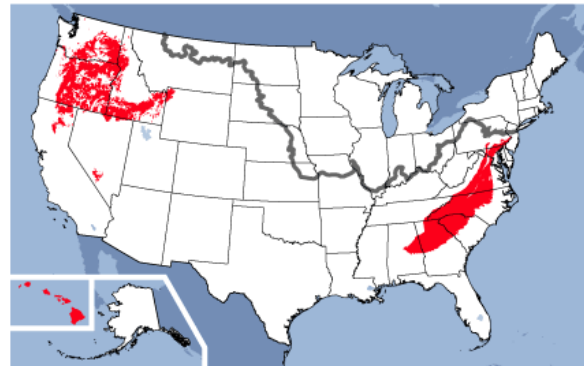

**Carbonate aquifers** include those made of limestone and dolostone as well as marble (metamorphosed limestone). The most important characteristic of carbonate aquifers is that their minerals can be dissolved by acidic water. The Floridan aquifer system, the Biscayne aquifer, and the Intermediate aquifer are all examples of carbonate aquifers, as is the Edwards aquifer system in Texas. Features of karst regions include large caves, disappearing streams, springs, and sinkholes. For a map of karst regions in the U.S., link to [http://www.northeastern.edu/protect/wp-content/uploads/US\\_KarstMap.jpg](http://www.northeastern.edu/protect/wp-content/uploads/US_KarstMap.jpg)

## Chapter 6 Darcy's Law

Potentiometric surface maps show the direction of groundwater flow. For many reasons, it is important to know how much groundwater is flowing and how fast the groundwater is moving. These can be calculated using **Darcy's Law**.

In the 1850's, Henry Darcy, an engineer, investigated how water flowed through various types of sand. He put sand in a cylinder in the laboratory, added small "wells" to measure the hydraulic head, and then measured the **discharge** (the volume of water per unit time) that flowed through the cylinder.

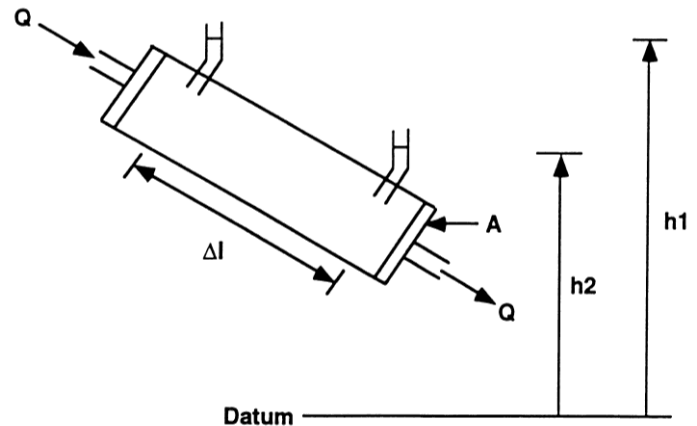

Darcy divided the discharge by the cross-sectional area of the cylinder,  $A$ , to get **specific discharge** (discharge per unit area),  $q = Q/A$

Example 1: If the cylinder has a radius of 2.0 cm, and the measured flow is 3.0 cm<sup>3</sup>/min, what is the specific discharge?

Answer.  $q = Q/A$ .

The cross-sectional area of the circle is  $\pi r^2 = \pi (2 \text{ cm})^2 = 12.56 \text{ cm}^2$ .

$q = 3 \text{ cm}^3/\text{min} / 12.56 \text{ cm}^2 = 0.24 \text{ cm}/\text{min}$

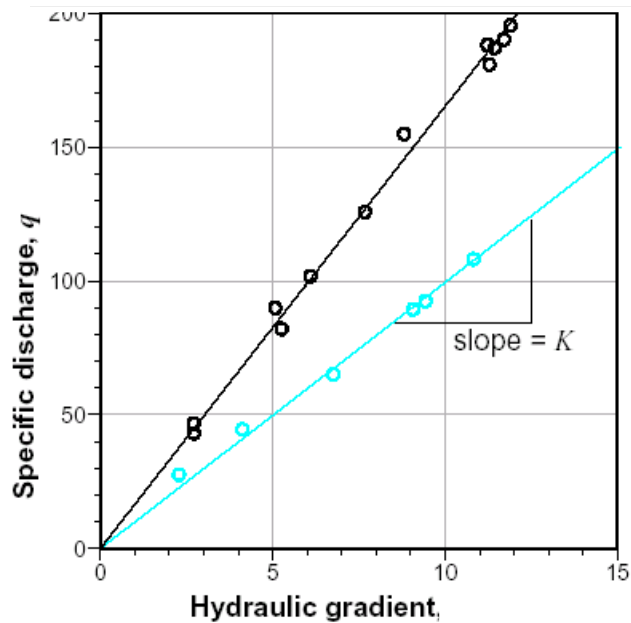

**Hydraulic gradient,  $i$** , is the difference in hydraulic head over length ( $\Delta l$ ):

$$i = (h_1 - h_2) / \Delta l$$

Example 2: If the length of the cylinder is 10 cm,  $h_1$  is 24 cm and  $h_2$  is 20 cm, what is  $i$ ?

Answer:  $i = (24 \text{ cm} - 20 \text{ cm}) / 10 \text{ cm} = 4 / 10 = 0.4$

Through a number of experiments, Darcy found that specific discharge increased linearly as the hydraulic gradient increased. This finding is called Darcy's law, and is written  $q = Ki$  or  $Q = KiA$

K is hydraulic conductivity and is the slope of the line relating q and i. Darcy tested different sizes of sand (shown by different colors on the graph) and calculated different hydraulic conductivity values for the different sand sizes.

Example 3: Use the specific discharge from Example 1 and the hydraulic gradient from Example 2 to calculate K.

Answer:

We can rearrange Darcy's Law to show that:  $K = q/i$

So  $K = 0.24 \text{ cm/min} / 0.4 = 0.6 \text{ cm/min}$

### Water Velocity

It can be very useful to determine how fast water moves. For example, you might want to estimate how long it would take a contaminant to travel a certain distance. If the cylinder used for the Darcy experiment had no sand grains in it, specific discharge would be the same as the **velocity** of the water. In an open pipe or a river,  $q = v$  and  $Q = vA$ .

On the other hand, the sediment grains in an aquifer block most of the cross-sectional area. The water can only flow through the effective porosity ( $n_e$ ), which is always less than 1. That means that the **velocity must be larger than the specific discharge**. We can calculate how much larger. The open area in an aquifer is  $n_e A$ . As a result:  $Q = v n_e A$  or  $q = v n_e$ .

Example 4: A. Use the specific discharge from Example 1 (0.24 cm/min) and an effective porosity of 0.30 to calculate velocity. B. How long would it take an average water particle to travel 100 m?

Answer: A.  $v = q/n_e = 0.24 \text{ cm/min} / 0.30 = 0.80 \text{ cm/min}$

B. First, make units consistent:  $v = 0.0080 \text{ m/min}$ .

Time = distance/ velocity =  $100 \text{ m} / 0.0080 \text{ m/min} = 12,500 \text{ min}$

**What is hydraulic head?** It is easy to determine hydraulic head by measuring the water level in a well, but what is it? Groundwater flow can be driven by either a difference in elevation or a difference in pressure. Water will flow from higher to lower elevations (like a stream flowing downhill). On the other hand consider a horizontal confined aquifer that has a higher fluid pressure on one side than the other. Water will flow through the aquifer from higher to lower fluid pressure.

Groundwater can even flow from low elevations to high elevations if the pressure difference is large enough.

**Hydraulic head combines the energy due to elevation and the energy due to the pressure of the water.** It is the mechanical energy per unit mass.

Groundwater flows from higher hydraulic head to lower hydraulic head. Along the flow path, the energy from elevation and pressure is converted to heat by friction. Generally the amount of heating is small enough that it does not significantly affect water temperature, but it does decrease hydraulic head. The higher the hydraulic conductivity, the less frictional resistance to flow.

### **Upper limit of Darcy's Law**

Most groundwater flow obeys Darcy's Law. The exception is when flow is very rapid, such as in underground cave systems or fractures. At high velocities, flow does not obey Darcy's Law. Similarly, stream flow will not obey Darcy's Law.

*\*\*\*FYI: If you've previously taken physics or fluid dynamics, you might be familiar with Bernoulli's equation and notice that we are neglecting the change in kinetic energy. This is generally reasonable for groundwater flow because the velocities are generally extremely small. As a result, change in kinetic energy is much smaller than the change in potential energy (due to elevation change) or the energy change due to differences in fluid pressure. The exception will be during high velocity flow, where Darcy's law will not apply due to the turbulent flow.*

## Chapter 7 Pumping and Groundwater Budgets

As described in previous chapters, hydraulic head drops when water is pumped from a well. This decrease in hydraulic head is called **drawdown**. Water flows towards the well from all sides making a **cone of depression** in the potentiometric surface.

For high rates of pumping, such as for cities, it is not practical to obtain all the necessary water from one well because the cone of depression would be too deep. Instead, a well field, which consisting of multiple wells, is used for the water supply. The wells are placed far enough apart to prevent the cone of depression from getting too deep.

### Wells and Aquifer Properties

According to Darcy's Law:  $Q = KiA$  or discharge equals hydraulic conductivity x hydraulic gradient x cross-sectional area.

That means that the hydraulic conductivity of an aquifer will affect the shape of a cone of depression. **For the same flow rate, an aquifer with a higher hydraulic conductivity will have a gentler cone of depression.**

The other important aquifer property is how it stores water. As mentioned in Chapter 1, unconfined aquifers store water by filling the pores of the unsaturated zone. As the water table rises, the pores fill up and as the water table drops, the pores drain. The amount of water that can be drained per volume of aquifer is the specific yield.

A confined aquifer is completely saturated, so full of water. It can only store water by increasing or decreasing the water pressure. As water is pumped from the aquifer, the water pressure drops. In a saturated sediment (or rock), the weight of the overlying sediment is carried by both the water and the sediment framework. The weight carried by the sediment framework is termed the **effective stress**. As hydraulic head decreases, the water carries less of

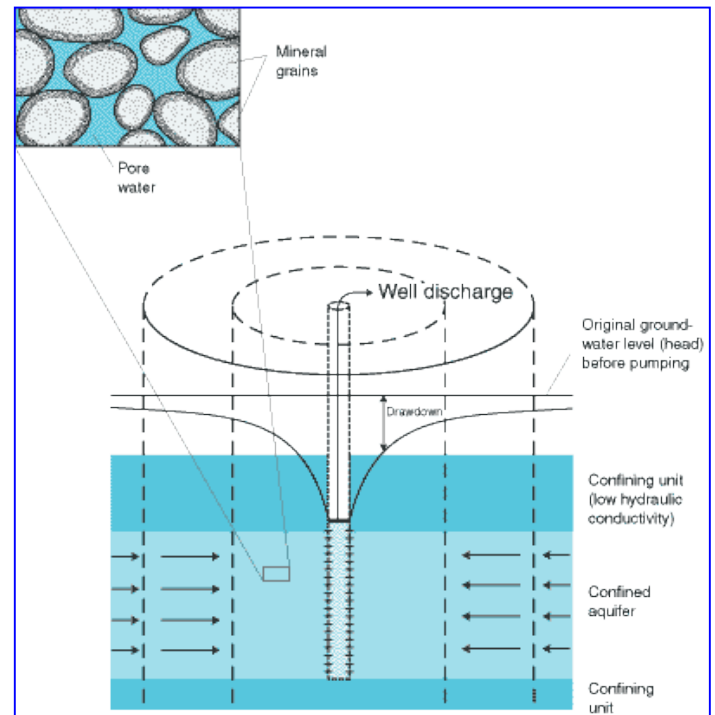

**Drawdown in a confined aquifer:** The pressure (and the potentiometric surface) drops, but the pores remain saturated. Water comes from aquifer compression.

the weight and the effective stress increases. The increase in effective stress causes the sediment framework to compress. When pumping is stopped and the aquifer is recharged, the water carries the weight again, and the aquifer expands. This is how water is stored in confined aquifers and is called **elastic** deformation, meaning that the deformation is reversible.

Think back (or look back) to the syringe experiment in Module 1. A lot more water can be removed per change in hydraulic head by draining pores (unconfined aquifers) than by compressing the sediment or rock (confined aquifers). That means that cones of depression are usually shallower in unconfined aquifers than in confined aquifers with similar hydraulic conductivities.

The most common way for hydrogeologists to determine an aquifer's hydraulic conductivity and storage is to pump a well at a constant rate and monitor the drawdown at a nearby well. This is called an **aquifer test**.

### **Negative effects of Pumping**

1. **Decrease of hydraulic head.** In an unconfined aquifer, shallow wells can go dry as the water table drops. In confined aquifers, water pressure drops, and flowing artesian wells might stop flowing.
2. **Mobilization of naturally occurring or human-introduced contaminants.** Because the pumping well pulls in water, it can change groundwater flow patterns. The water flowing to the well can carry contaminants from spills and leaks. As an example, the contamination that has reached the upper Floridan aquifer beneath the Cabot-Koppers site in Gainesville may eventually reach the Murphree Well Field. Saltwater intrusion can also be caused by pumping, and will be further discussed in Module 11.
3. **Effects on surface water (discussed further below)**
4. **Subsidence (discussed below) and sinkholes (Module 8)**

### **Effects of groundwater pumping on surface water**

A common problem facing users of aquifers is overuse. As you learned previously, the **water budget (or water balance) equation** states that:

$$\text{Inflow-Outflow} = \text{Change in Storage}$$

Before development, many aquifers are at a steady state. There will be seasonal changes and cycles of high precipitation and droughts, but over the long-term (decades)

recharge will balance outflow and the water table will remain relatively stable. Pumping adds a new outflow. Unless recharge increases --such as from humans adding water to the aquifer-- or other forms of discharge decrease, water storage will decrease. As a result, the hydraulic head will decrease. In unconfined aquifers, the water table will drop, and in confined aquifers, the water pressure will decrease.

To reach a new steady state, groundwater pumping must either increase recharge or reduce other types of discharge.

Consider what happens to a gaining stream (shown in Figure A). When pumping begins, it creates a cone of depression (B) and removes water that would have otherwise discharged to the stream. As a result, the stream flow is decreased.

If the cone of depression reaches the stream (C), the gaining stream can be turned into a losing stream. This can help to balance the aquifer's budget and prevent further drops of the water table. However, it can have undesirable effects on the flow within the stream. As streamflow decreases, aquatic ecosystems can be affected, recreation can be diminished, and navigation of the stream or river can become more difficult.

Flow to springs can also decrease, or even stop, as hydraulic head decreases due to pumping. Lakes and wetlands that are connected to the water table can also go dry. In terms of the water budget, this can reduce losses of water to evapotranspiration.

What happens if a new steady state can't be reached? If pumping continues at an unsustainable rate, the potentiometric surface will continue to drop. This is termed **groundwater mining**, similar to extracting non-renewable resources. The ongoing

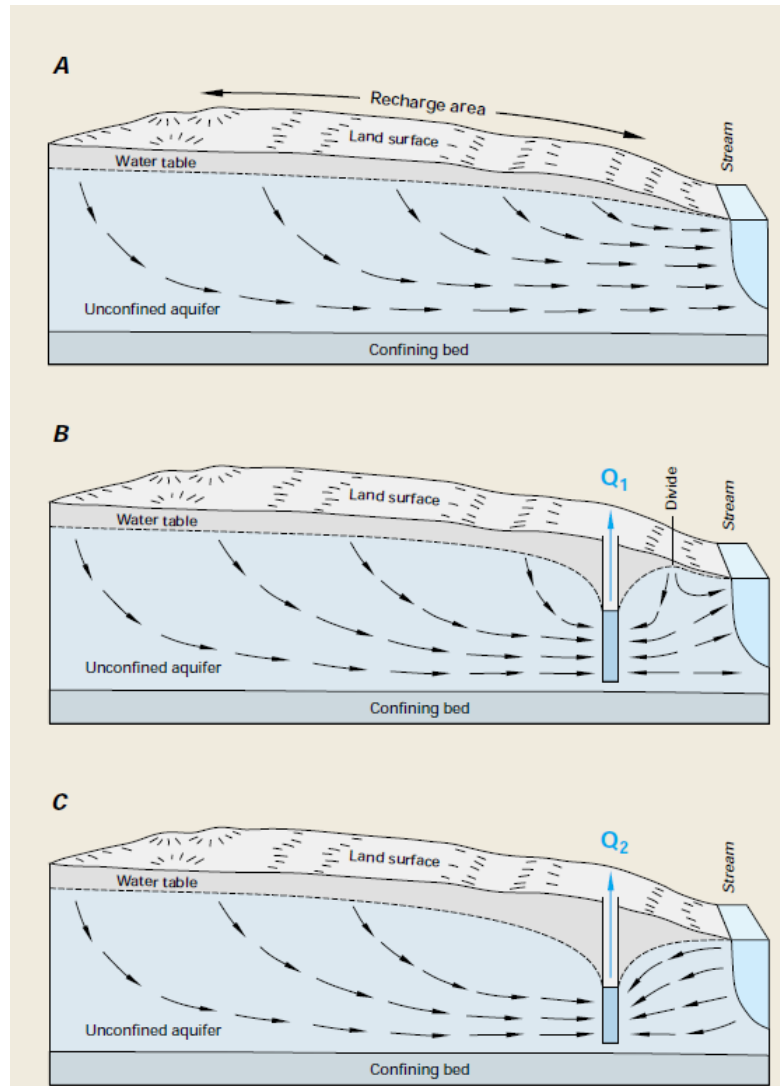

depletion of the High Plains aquifer is an example of groundwater mining. Eventually, a new source of water will need to be found.

## Subsidence due to groundwater removal

### Compaction due to increased effective stress

When groundwater is mined, hydraulic heads can drop lower than ever before. Effective stress will become higher than the sediment has ever experienced before. When this happens, the sediment becomes permanently rearranged into a more compact arrangement. This compaction is not reversible and is called **plastic** deformation.

Clays generally compact a lot more than sand or gravel. **As a result, most subsidence problems occur where aquifers are interlayered with clays.** Because clays have low hydraulic conductivity, there will be a time lag between when the hydraulic head drops in the aquifer(s) and when it drops in the clay layers. Basalt aquifers or aquifers that are fractured igneous rocks are less likely to experience subsidence because of the rock's strength.

Damage due to subsidence includes fissures in the ground, and damage to roads and buildings. In addition, subsidence can increase flood hazards in areas near rivers or the ocean. For example, Houston and Galveston, Texas have subsided up to 10 feet due to a combination of oil and water removal. This has caused coastal wetland loss due to salt water and increased coastal flooding during hurricanes.

Subsidence can occur as a result of long-term pumping that lowers hydraulic head, increases effective stress, and causes clays to compact.

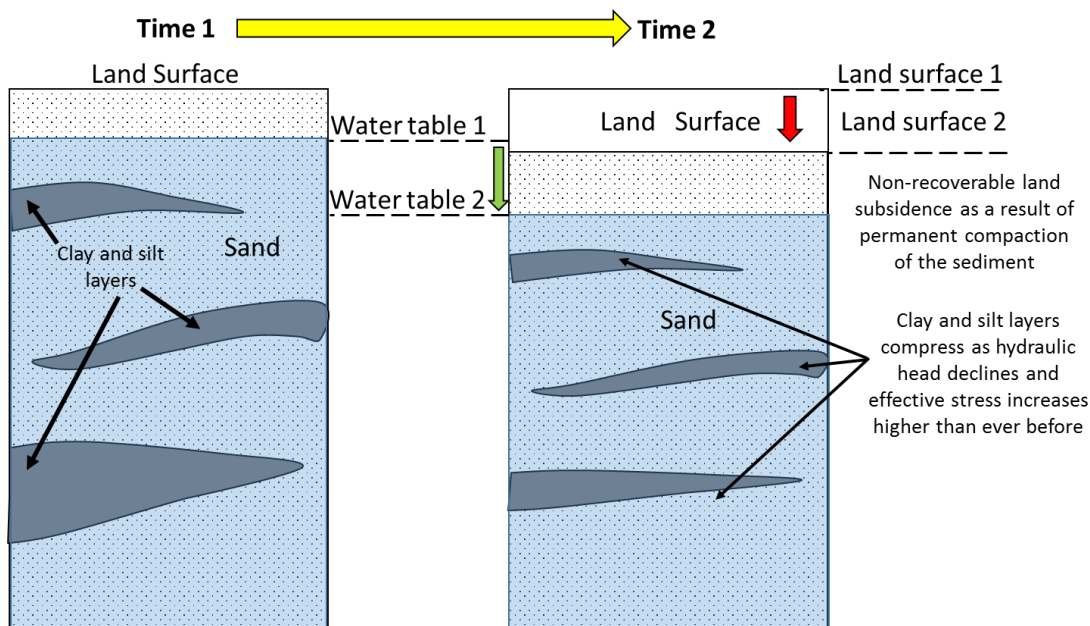



## Chapter 8 Water Management

A common problem with water supply is that there is too much water at some times and not enough water at other times. This problem is particularly apparent in surface water, where streams can change from dry or very low flows to flood conditions.

### Too much water

Man-made **levees** are constructed embankments or walls which are designed to keep streams within their channels and prevent damage due to floods. At the same time that levees protect developed areas or farmland in the stream's floodplains, they also increase downstream flooding. Unlike dams, discussed below, levees don't provide any water storage, so do not help with low flow conditions. In fact, levees reduce water storage by preventing flood water from reaching the floodplain and in the adjacent aquifer. As a result, the flood peak is rapidly transmitted downstream. Levees can also fail during large floods. Overtopping occurs when the water level exceeds the levee height. During overtopping, the water undermines the outside of the levee. Seepage through levees can also lead to failures.

**Dams** are an important part of surface water use and flood control. In terms of flood control, dams can reduce the peak flood by storing water in the reservoir upstream of the dam. Early dams were built for mills (grinding grain) and later for power generation. During the 1800s, the Army Corps of Engineers focused primarily on ensuring that waterways could be navigated. This effort included construction of dams in upstream areas to store floodwaters. Gradual release of this water throughout the remainder of the year allowed enough discharge for ship traffic. Dam building in the U.S. greatly increased in the early 1900s, peaking between the 1930s and 1960s. The main reasons for dams were for flood control and hydro-electric power generation. Storing water for irrigation was an additional motivation for dam building.

Just as there can be too much surface water, there can be too much groundwater. High water tables can flood basements and low-lying areas and damage building foundations.

In areas prone to **landslides**, high hydraulic heads can help to trigger failures. Landslides are the downslope movement of rock and soil due to gravity. They cause extensive damage (estimate >\$1 billion each year in the U.S.) and even deaths (25 to 50 each year). Groundwater affects slope failure in a couple of ways. First, if the water table in a slope rises, the weight of the material increases. This can increase the driving force for landslides. Secondly, increased fluid pressure reduces the contact between sediment grains or minerals within rocks. As the contact between grains is reduced, the slope's resistance to sliding, or **shear strength**, is reduced. As a result, slope failures (landslides) often occur after heavy rainfalls recharge the aquifer.

In some cases, high underground water pressures can even trigger earthquakes. The mechanics of **fault movement**, including sudden movement that causes earthquakes, are very similar to landslides. The major difference is that the driving force for fault movement is tectonics rather than gravity. As with landslides, high water pressures along fault zones can reduce the shear strength and allow faults to slip. Earthquakes have also been triggered by injection of water during hydrofracturing for gas extraction and for geothermal energy production.

## Too little water

*Water laws attempt to allocate water rights. This chapter focuses primarily on the U.S.; however, the basic issue --- are water rights are tied to the land or are they separate from land ownership? – applies across the world.*

## Surface Water Law

**Riparian water rights** tie use of water to the land adjacent to the waterway. The landowner may use the water, but does not own the water. This doctrine evolved from the “natural flow doctrine” which allowed the owner of land near a water way (or “riparian” land) to receive and return water to a stream as it came naturally to their land (without changes to its flow, volume, temperature, and quality). This type of water use, in which it is returned to the waterway, is termed **non-consumptive use**. For practical reasons the doctrine evolved with time to allow riparian landowners **reasonable use** of water on lands adjacent to the waterways. This included **consumptive use**, in which the water is not returned to the waterway. “Reasonable use” was judged in the context of competing uses. That means that as new owners or uses occurred, all previous owners’ rights could be adjusted. An important aspect of the reasonable use doctrine is that in times of shortage, all users were affected.

In contrast, the **doctrine of prior appropriation** focuses on ownership of the water rights, rather than land adjacent to waterways. Water rights are established by diverting water for a beneficial use (water flowing downstream was considered wasteful) and the earlier that water rights were established, the higher priority the use is considered. In times of shortage, senior rights have precedence. In the earliest version of prior appropriation, there was no incentive for efficiency. If less water was used, the rights to the unused portion would be lost. In some cases, this has been modified to better encourage conservation.

Historically, Eastern states have followed the riparian doctrine, whereas most Western states followed the prior appropriations doctrine. Unlike with the riparian doctrine, where use was historically local (or at least within the watershed), prior appropriations allowed long-distance transfer of water. For example, Southern California obtains water through hundreds of miles of aqueducts from the eastern side of the state (the Owens Valley and Mono Lake), the Colorado River on the Arizona border, and central California.

In the East, reasonable use has been expanded to include considerations such as environmental protection and recreational uses of the waterway. In addition, growth has led to

more frequent water shortages. To provide a more predictable water supply, states such as Florida have adopted some aspects of the prior appropriations by creating a system where permits are granted for consumptive water use. Furthermore, the transfer of water between watersheds has gradually been allowed.

In the West, beneficial use has also grown to include in-stream uses such as recreation and fish and wildlife protection. The prior appropriations doctrine also changed to allow selling of water rights rather than the rights being lost if the water was not used.

### **Groundwater Rights**

Before groundwater flow was understood, many states followed the “**Rule of Capture**”. This rule was based on the idea that it was not possible to predict groundwater movement, and thus it could not be regulated but could be captured (like a wild animal). The Rule of Capture gave landowners “Absolute Rights” to water beneath their property and allows landowners to pump as much ground water from beneath their land as needed without liability for interference with others. The only prohibitions concerned waste and malicious intent. This rule is still followed in Texas but has been abandoned in other states as it became recognized that water could move from beneath neighboring properties and between surface and groundwater.

The Reasonable Use doctrine has become more common. This allows landowners to use the groundwater beneath their land for a reasonable use on the land above the aquifer. A groundwater analog for riparian rights (applicable to surface water) is correlative rights, which is used in California. Groundwater can be used by landowners as long as it does not interfere with other users. In case of shortage, all users are affected.

### **Water permitting**

As water use has increased and conflicts occurred, some states have moved to a water permitting system. In some western states, the water permitting follows the prior appropriations doctrine in which senior users have priority. In locations where surface water historically has followed the riparian doctrine, groundwater permitting is often for a “pool” of rights, with all users being affected by shortages. New permits are generally granted if the use is reasonable and in the absence of harm to other users or the “public interest”, which can include considerations such as the environment. In some cases, states may have permitting for only surface water, only groundwater, or for both surface and groundwater.

### **Surface and groundwater exchange**

The exchange between ground and surface water presents difficulties in states that have distinct allocation systems for each. Consider a well pumping near a stream. It is likely removing water that would have provided baseflow to the stream or, if pumping rates are high enough, causing the stream to lose water to the aquifer. As a result, the same water may be allocated as both surface water and as groundwater. In some prior appropriations states, groundwater that is connected to surface water (“tributary groundwater”) may be treated as part of the surface water resource. In contrast, “non-tributary groundwater” may be tied to property. As you might imagine, separating tributary from non-tributary groundwater can be challenging because even water in confined aquifers might contribute to streams (although it could take centuries). Additional challenges arise in karst aquifers, because streams may flow into sinkholes and continue underground. These “subterranean rivers” are generally treated as surface water.

## Interstate conflicts

Conflicts concerning rivers or lakes that border (or cross) several states are generally solved by **interstate water compacts**, which are permanent divisions based on beneficial use. One of the most well-known Interstate Water compacts concerns the water of the Colorado River. In 1922, this compact divided the water of the Colorado River between 4 states in the upper basin and 3 states in the lower basin (and later Mexico). Another conflict location is the Apalachicola/Chattahoochee/Flint River, which impacts Georgia, Florida, and Alabama. Lake Lanier, created by a dam on the Chattahoochee River, is the primary water source for Atlanta, Georgia. During droughts, use of the water affects downstream uses, including the seafood industry in Apalachicola Bay, Florida. The three states have not yet reached an agreement.

## International conflicts

Conflicts concerning international disputes arise over surface water hydroelectric power, navigation, and consumptive use. If resolved, it is generally by treaty. Most of these conflicts have focused on surface water, but aquifers that cross national boundaries (transboundary aquifers) are an emerging issue.

---

## Florida water law and management

The Florida Water Resources Act of 1972 is a blend of reasonable use and prior appropriations. Consumptive water use requires permitting by one of Florida's **5 water management districts**. The water management districts are responsible for evaluating any consumptive use permit request as to whether it is a reasonable, beneficial use that is consistent with the public interest and does not interfere with pre-existing legal uses.

In addition to permitting, water management districts are responsible for water quality monitoring, water level and flood monitoring, and have also purchased land to protect aquifer recharge areas. Funding of the districts is from property taxes. There are water permit fees, but no fees for the water itself. *(Note: while pumping your own water is "free", there is a charge for municipal water service -- such as GRU. The delivery of water may be either a government responsibility or provided by private companies.)*

Some innovations in the Florida system are the consistent treatment of surface and groundwater, management boundaries following watersheds rather than cities/counties, and a

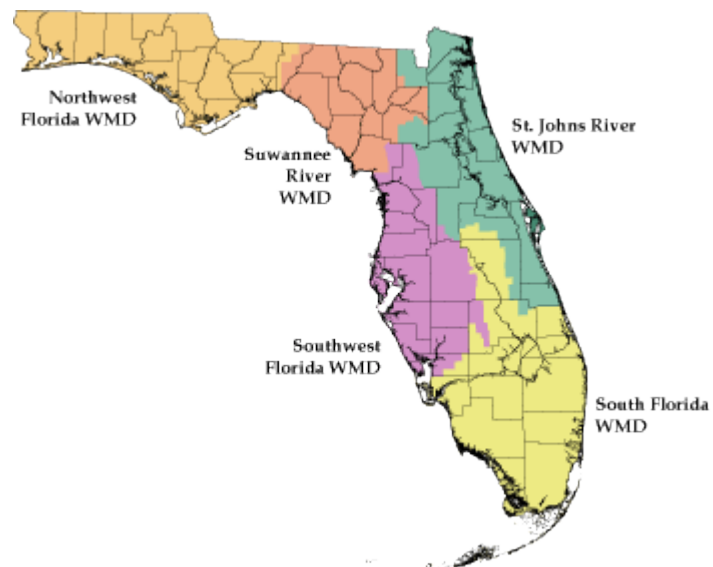

legal emphasis on environmental protection. The water districts were instructed to establish **Minimum Flows and Levels (MFLs)** for surface water necessary to prevent significant harm to the water resources or ecology of an area resulting from water withdrawals. These MFLs are still being established, and are intended to be used to guide consumptive use permitting and to declare water shortages. Difficulties with Florida water law and MFLs include the vagueness of “significant harm”, the lack of a connection between the water districts and cities and counties responsible for growth and planning, and the lack of a clear rule on water transfers between districts.

---

## Management Options

In addition to monitoring water conditions and deciding on consumptive use permits, water managers are responsible for developing long-term strategies for increasing water demand. Some management options include:

- Encourage and/or enforce water conservation
- Find new sources of water (surface water, new groundwater sources, desalinization, imported water) or reuse wastewater.
- optimizing location of pumping to minimize negative effects (for example, moving the pumping well farther from the coast to prevent contamination by saltwater or farther from a stream to prevent it from pulling in stream water).
- groundwater “**mining**”. This is not sustainable but instead means to accept that the use is “one time” or non-renewable. This occurs in aquifers where the resource is needed and the benefits are judged to outweigh the costs.
- Store water during times of high rainfall.
  - Surface water storage uses **dams** to hold water in reservoirs at the surface. Dams can also provide flood control and hydroelectric power and the reservoirs are also used for recreation. The disadvantages of surface storage are: 1) Land area is flooded, disrupting ecosystems and humans; 2) changes in water levels in surface water affect the surrounding aquifer and – in areas prone to hazards – landslides and earthquakes have resulted; 3) disruption to sediment transport as sediment is deposited upstream of the dam in the reservoir and downstream river banks and beaches are sediment starved; 4) water temperature and discharge changes downstream affect ecosystems; and 5) evaporation greatly increases, particularly in arid regions.
- Storage can also be within aquifers. **Artificial recharge** can take several forms:
  - ▣ Spray fields of treated water help to recharge aquifers. Water quality issues are important.
  - ▣ **Recharge basins** hold the water (stream water or storm runoff), providing it time to infiltrate to the aquifer. This allows recharge of water during floods that would otherwise flow to the ocean. Issues with recharge basins are the water quality of

the runoff. In addition, recharge basins can allow significant evaporation, which can reduce water quantity and increase the concentration of dissolved solids.

- ▣ For confined aquifers, surface spreading or recharge basins cannot be used, and the artificial recharge must use recharge wells. This is called **aquifer storage and recovery**. Water is pumped into the aquifer when it is plentiful and out of the aquifer when there is a shortage. Advantages of aquifer storage and recovery, as compared to surface reservoirs, are that there are no losses to evaporation and no wasted land area. Disadvantages are the energy cost to pump the water in and out and concern about water quality effects.

## Chapter 9 Water Chemistry

The hydrogen and oxygen atoms in water form a molecule that is “polar” or not symmetrical. That allows the positively charged hydrogen and the negatively charged oxygen to attract other polar molecules and charged molecules. As a result, water is an effective **solvent**, which means that it can dissolve gases, liquids, and solids. **Solutes** are carried in the water as ions. **Cations** have a positive charge (example: Na<sup>+</sup>) and **anions** have a negative charge (example: Cl<sup>-</sup>). Solutes can also be non-ionic (uncharged). Dissolved constituents are typically expressed in mg/L (milligrams per liter) for the major components and µg/L (micrograms per liter) for the trace elements.

In water chemistry, it is common to discuss a solution being **undersaturated**, **saturated**, or **oversaturated** with respect to a particular mineral. A saturated solution means that it is at equilibrium (or steady-state) and will not dissolve or precipitate the mineral. An undersaturated solution is capable of dissolving the mineral, and an oversaturated solution will tend to precipitate the mineral (in other words, crystals will start to form from solution).

Understanding water chemistry is very important for a number of reasons:

- Water chemistry can provide important clues as to flow paths because water dissolves the minerals within the aquifer that it passes through.
- Natural and human-created tracers can indicate groundwater ages and thus flow velocities.
- Chemical reactions – particularly dissolution and precipitation of minerals --- can change an aquifer’s hydraulic conductivity. Dissolution can also lead to sinkholes, which can be important geohazards.
- Introduced and natural contaminants can make water unusable and affect aquatic ecosystems.

### Water Sampling

Sampling techniques depend on the questions to be answered and the type of water body being sampled. Surface water can be sampled directly, but the sampler should ensure that they are getting representative water, not stagnant water. A collection bottle can be lowered into the water or a pump used to collect the water. Groundwater can be sampled from faucets (keeping in mind that water pipes may affect the water chemistry) or from springs and wells.

Common water chemistry samples collected include:

- Dissolved ions
  - Major ions in water are calcium, magnesium, sodium, potassium, chloride, bicarbonate, sulfate
- Metals
  - Common metals include iron, manganese, copper, lead, mercury
- Carbon

- Organic carbon
- Inorganic carbon
- Nutrients
  - Nitrogen
  - Phosphorus

Water sampling must be conducted under controlled conditions to ensure the correct measurement of water chemistry. When sampling wells, stagnant water must be removed (or **purged**) to ensure that a representative ground water sample is collected. Usually, a pump is used to purge the well and collect the water sample. For wells, often 3 to 5 times the volume of the well are purged before sample are taken. During purging and sample collection, the water is monitored for basic properties including:

- Temperature – shallow groundwater generally reflects the average annual air temperature (<http://smu.edu/geothermal/heatflow/surtemp.htm>). Temperature in deeper groundwater reflects the increase in temperature with depth into the earth (<http://smu.edu/geothermal/heatflow/ThermalGradientmap.gif>). Temperature can be a useful indication of whether you are sampling water that has been sitting in the well or really represents the groundwater.
- **pH** – acidity of water
- **Specific Conductivity or Conductance** (SpC) –the electrical current that can be carried by water is proportional to the amount of dissolved ions in solution. This parameter can be related to the total concentration of solids dissolved in the water, called the **Total Dissolved Solids** (TDS).
- **Turbidity** – a measure of suspended solids in the water. If turbidity is too high, it can mean the well development was not sufficient. This can cause errors in measurements of solutes.
- **Dissolved oxygen**

After a water sample is collected, it is taken to a laboratory for analysis. It is important to realize that laboratories generally test for specific solutes. In other words, they do not test every single solute that could be in the water. As a result, contaminants can be missed. It is also important to realize that the health effects of some contaminants has not yet been fully evaluated. For example, a contaminant called 4-Methylcyclohexanemethanol (MCHM) was spilled into the Elk River in West Virginia this past year. There has been conflicting advice on whether the water is safe to drink because there has been little previous testing of MCHM (<http://emergency.cdc.gov/chemical/MCHM/westvirginia2014/index.asp> ).

## Natural Water Chemistry

Rain falling to the surface of the earth contains dissolved gases such as oxygen, carbon dioxide, sulfur dioxide, and low concentrations of dissolved ions. The composition of the dissolved ions reflects the dusts and aerosols present in a region. For example, the distribution of sodium and chloride in rainwater reflects the ratio of



these ions in seawater along the coast. The chemistry of rainwater has been altered by emissions of sulfur dioxide and nitrogen oxides. Where these gases are present in elevated concentrations rain is more acidic.

At the surface and in the soil zone, evapotranspiration removes pure water increasing the concentration of any dissolved solids. In addition, water continues to dissolve soil gases. Due to respiration in the soil zone, CO<sub>2</sub> can have concentrations in soil gas much greater than in the atmosphere. Dissolution of carbon dioxide increases the acidity of soil water.

Water also dissolves organic compounds that originated as living tissue. Natural organic compounds include humic and fulvic acids generated from the decay of organic matter. In solution, they can give water a yellow to brown color, which is seen in many of Florida's rivers. Below the water table, groundwater becomes isolated from the atmosphere. In this closed system, oxygen will be depleted as organic matter decays.

**Dissolution by Groundwater** Throughout its flowpath, groundwater interacts with the minerals of the aquifer and confining layers. The most soluble (and generally most rapidly dissolving minerals) are halite (NaCl), gypsum, calcite, and dolomite. Salts such as halite and gypsum are most commonly found in evaporite deposits, either on the land surface in regions where they have been concentrated by evapotranspiration (such as the salt flats surrounding the Great Salt Lake) or at depth, where evaporate deposits from the past have been buried.

Carbonate minerals such as calcite and dolomite are widespread and influence groundwater chemistry in many aquifers. Water in carbonate terrains tends to be dominated by Ca<sup>2+</sup> (and Mg<sup>2+</sup> in the presence of dolomite) and bicarbonate (HCO<sub>3</sub><sup>-</sup>). Carbonate solubility is greatly affected by the concentration of carbon dioxide in the water and the pH of the water. Newly recharged water, which has percolated through the soil zone, generally has high carbon dioxide concentrations. As calcite or dolomite dissolve, carbon dioxide concentration decreases and the solution becomes saturated. As a result, dissolution will generally be highest in the unsaturated zone and in recharge areas and decrease along the groundwater flow path.

The solubility of non-carbonate

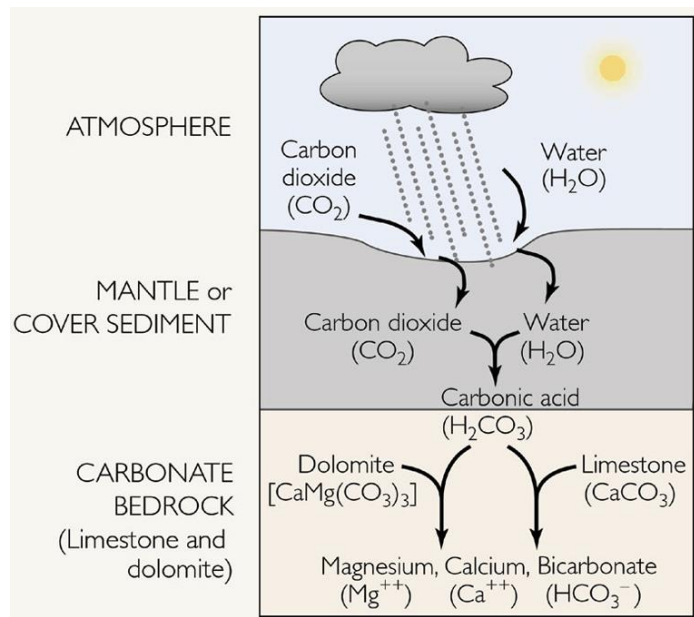

minerals in igneous and metamorphic rocks is generally much lower than for carbonate rocks. Igneous rocks such as granite are dominated by quartz, feldspar, and micas, such as biotite (see <http://www.ucl.ac.uk/es/impact/geology/london/stpancras/weathering/granite> for a picture of these minerals in granite). The solubility of quartz is quite low (explaining why quartz crystals often survive to be deposited in stream channels and beaches). Reactions affecting other minerals in igneous and metamorphic rocks (feldspars and mica), tend to release  $\text{Na}^+$ ,  $\text{K}^+$ ,  $\text{Mg}^+$ , and  $\text{Ca}^{2+}$ .

In dissolution of calcite and evaporites (such as halite and gypsum), the mineral is completely removed (termed **congruent dissolution**), opening pore space. In weathering of feldspars and micas, a residual clay mineral is formed, and the process is termed **incongruent dissolution**. The types of ions found due to interaction with rocks and minerals are shown in the table below.

common cations	Sources	common anions	Sources
$\text{Ca}^{2+}$	Limestone ( $\text{CaCO}_3$ ), gypsum ( $\text{CaSO}_4 \cdot 2\text{H}_2\text{O}$ ) anhydrite ( $\text{CaSO}_4$ ) Weathering of igneous/metamorphic rocks	Bicarbonate ( $\text{HCO}_3^{2-}$ )	Decay of organic matter Limestone and dolomite
$\text{Mg}^{2+}$	Dolomite $\text{CaMg}(\text{CO}_3)_2$ Weathering of igneous/metamorphic rocks	Sulfate: ( $\text{SO}_4^{2-}$ )	gypsum ( $\text{CaSO}_4 \cdot 2\text{H}_2\text{O}$ ) Pyrite ( $\text{FeS}_2$ )
$\text{Na}^+$	Halite ( $\text{NaCl}$ ) Plagioclase	$\text{Cl}^-$	$\text{NaCl}$
$\text{K}^+$	Sylvite ( $\text{KCl}$ )		

## Sorption

Solid phases can alter water chemistry because ions can **sorb** to the surface or within the solid, removing these ions from solution. Organic material, clays, iron oxides, and manganese oxides are examples of solids that alter the water chemistry of surface and ground water by sorbing ions from solution. In general, low solubility molecules tend to be more likely to sorb onto solids.

Sorption, pH, and redox all have critical controls on the quality of water. The degree to which trace metals sorb to solid surfaces varies through the pH range found in natural waters. In general, metals sorb less strongly at low (acidic) pH. That means that if pH is changed, metals can be released into the water.

## Oxidation-Reduction (redox) reactions

Redox reactions involve the exchange of electrons. **Photosynthesis** is an important redox reaction in which carbon dioxide is reduced to form organic carbon, or sugar). The reaction requires sunlight for energy and releases oxygen. During **respiration** (both by plants and animals) the organic carbon is oxidized, releasing energy and carbon dioxide. **Decay** of organic matter accomplishes the same oxidation of organic matter, and is generally mediated by micro-organisms. If oxygen is available it will be used first because it provides the most energy, In closed systems (deep lakes or groundwater), oxygen can become “used up” and nitrates, manganese, iron oxides, and sulfates will be reduced (in that order).

## Temperature

The temperature of shallow groundwater is approximately the same as the average yearly air temperature. That is why springs in our area are 20°C (~70°F) year-round. In the summer, the water is cooler than the air temperature and in the winter it is warmer. This stable temperature can be valuable for ecosystems in surface water fed by groundwater.

Groundwater in deeper flow paths generally warms due to higher temperatures beneath the surface. The rate that temperature increases with depth, or the **geothermal gradient**, is around 20°C/km in Florida. In contrast, the gradient can be much higher (45°C/km or more) in some parts of the western U.S. where the earth's crust is thinner and/or magma is near the surface.

Water temperature can also affect the chemical reactions that occur. Solubility of some ions is temperature dependent. Many ions have higher solubility at higher temperatures. For example, you can dissolve more halite (NaCl) in warm water than in cold water. In contrast, some gases have higher solubility at low temperatures. Oxygen and carbon dioxide --two very important gases in water --- become less soluble as temperature increases. This can have implications for ecosystems as well as chemical reactions. For example if groundwater dissolves calcite and then continues to migrate to greater depths (and warmer temperatures), the calcite might precipitate out of solution into pore spaces.

## Ch 10 Water quality

### Surface Water Quality

The quality of surface water depends on what is transported in runoff or in groundwater if it discharges to the surface water. Evaporation can also be important, because it increases concentrations of solutes by removing pure water. If concentrations become very high, the solution can become supersaturated, leading to precipitation.

- **Sediment** is generally carried by runoff. It increases turbidity and can greatly impact surface water ecosystems by blocking light transmission.
- **Temperature** is affected by the temperature of water source and exchange with the atmosphere.
- **Dissolved organic matter** affects the water color and light transmission. Decay of organic matter can consume oxygen and alter pH and redox conditions.
- **Dissolved oxygen** enters water from exchange with the atmosphere and photosynthetic plants. It is removed by respiration and by decay of organic matter by microbes.
- **Total dissolved solids** are affected by the solubility of the rocks and sediments that water contacts. Because contact time is longer in groundwater and contact area is greater (per volume of water), groundwater often has higher TDS than surface water.
- **Nutrients** are not major ions in water, but are essential to photosynthesis. The two most common **limiting** nutrients for aquatic ecosystems (those that control productivity) are nitrogen (often in the form of nitrate) and phosphorus. In natural systems, nitrogen is generally supplied by nitrogen-fixation from the atmosphere and phosphorus is generally provided by weathering of minerals.
- **Microbes** exist in water bodies (and in the human body!) and play an important role in decomposition of organic matter. Some, termed pathogens, cause disease. These include water-borne viruses and bacteria.

### Surface Water Productivity

The **trophic** status of a water body reflects its nutrient levels and plant growth (see figure from the USGS Primer on Central Florida Lakes below). **Oligotrophic** lakes have low nutrients and little plant growth while **eutrophic** lakes have high concentrations of nutrients and high levels of plant growth. **Mesotrophic** lakes are in between. While nutrients sound like a good thing, addition of nutrients can cause **eutrophication**, which is an increase in productivity.

A common cause of eutrophication is runoff or infiltration containing nitrates and phosphates from **fertilizer**. Fertilizer is made from nitrates (generally from nitrogen gas

in the air), phosphates (generally mined from the ground), potassium, and other micro-nutrients. Fertilizer use can greatly increase the nutrient concentrations in surface and groundwater. Farming and landscaping practices can greatly reduce the loss of fertilizer to the environment.

Eutrophication can lead to problems including algae blooms. As these blooms decay and consume oxygen, **hypoxic** (low oxygen) conditions can threaten aquatic organisms. In addition to productivity, oxygen concentrations in water will also be affected by the water source, residence time, and mixing with the atmosphere. The turbulence of streams mixes in oxygen from the atmosphere. In contrast, low-energy environments such as deep lakes can be oxygen depleted due to decay of organic matter.

This is especially true of lakes that receive groundwater. Very low (to zero) oxygen concentrations are common in groundwater, especially in deep aquifer flow paths.

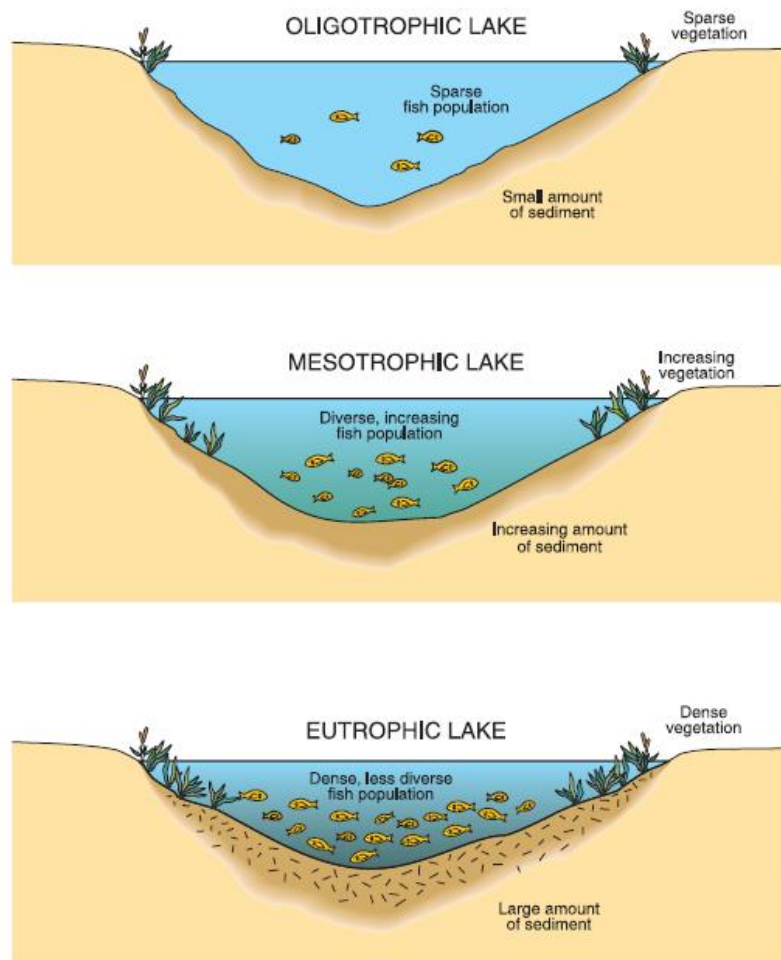

**Pollutants** can either be point-source, when from a specific location (for example, a landfill), or non point-source, when the cause is dispersed. As mentioned above, nutrients are one type of non point-source pollutant.

Sources of contamination include:

**Waste from Animals/Humans** Manure and human waste can contribute organic matter, pathogens, and nitrates to water. Nitrates can be a contaminant in drinking water according to the EPA, causing shortness of breath and even death in infants under 6 months old. Nitrates can also contribute to eutrophication problems. Waste can also carry bacterial and viruses. An emerging area of concern is pharmaceuticals and personal care products, which have been found in surface and groundwater. These are

generally contributed by improper disposal of pharmaceuticals/personal care products or are carried in the waste.

There are many parts of the world where sewage is just disposed with no treatment – or re-used for agriculture. Where wastewater is treated, it is generally through either septic systems or wastewater treatment plants. **Septic systems** are generally more common in rural, low-population density areas. These systems consist of two parts -- a tank where helpful microbes break down household sewage under anaerobic conditions and a drainfield where the liquid is distributed to infiltrate into the ground. The need for a drainfield means that septic systems are not practical for high-population density areas.

For septic systems, soil must be permeable enough so that the waste water can infiltrate as quickly as it is produced. Otherwise, the waste liquid will rise above the ground surface. On the other hand, if the sediment or rock beneath the drain field is too permeable, waste water enters the water table too quickly. There will not be enough time for aerobic microbial activity to break down any organic material or use remaining nutrients. Karst aquifers are particularly vulnerable to septic tank contamination because of conduits formed by dissolution. Problems with septic tanks can also arise where the water table is high. Again, there would not be sufficient time for aerobic microbial activity. In some cases, homeowner may be required to add a foot or two of sediment before installing a septic tank and drainfield.

Where population density is high, **waste water treatment plants** is preferred to septic systems. Although there variations in treatment, commonly the waste water is screened to remove non-treatable material, aerated to allow microbial decomposition, removal of solid sludge, skimming of “scum” such as oils and soaps, and disinfection (often through chlorination). The wastewater is disposed to surface water, re-used, or used to recharge aquifers. The sludge is subjected to further microbial digestion and then landfilled or used as fertilizer.

**Agriculture and lawns** contribute insecticides, herbicides, pesticides, and nutrients (N and P) to surface and groundwater. In agricultural areas, best management practices (BMPs) are being used to try to reduce runoff or infiltration of contaminated water. These include controlling runoff and soil erosion and optimization of fertilizer usage. In some states, lawns have been identified as a significant source of nutrients. Efforts to reduce lawns’ impact on water include homeowner education as well as restrictions on lawn fertilizer compositions, release speed, times of application, and “no fertilizer” zones near surface water. (FYI: a 2012 summary can be found here <http://www.cga.ct.gov/2012/rpt/2012-R-0076.htm> )

At **industrial sites and during transport**, contamination can be caused by spills. Hydrocarbons are common in spills. Industrial chemicals that are common in water

contamination include cleaning solvents and degreasers (synthetic organic compounds). A few of the most common synthetic contaminants are carbon tetrachloride, trichloroethylene (TCE), perchloroethylene (PCE), dichloroethylene (DCE), and vinyl chloride (VC). Many contaminants, such as metals or chlorinated hydrocarbons, do not dissolve easily in water. Unfortunately, the level of contamination that is hazardous can be very low (a few parts per billion).

## Regulations

There are a variety of regulations at federal, state, and local levels. Some of the relevant federal legislative acts are:

- The 1972 **Clean Water Act** gives the U.S. Environmental Protection Agency the authority to regulate point-source discharge of pollutants. It also requires states to identify intended uses of surface water and establish water quality standards.
- The 1973 **Endangered Species Act** (<http://www2.epa.gov/laws-regulations/summary-endangered-species-act>) provides for the conservation of threatened and endangered species. This can be used to enforce water quantities sufficient for the endangered species, but can also be used to enforce water quality. If endangered species live in water or depend on water for food, they can be harmed by poor water quality. The lead agencies are the Fish and Wildlife Service and the National Oceanic and Atmospheric Administration (NOAA), who coordinate with the EPA on water-quality issues.
- The 1974 **Safe Drinking Water Act** (<http://www2.epa.gov/laws-regulations/summary-safe-drinking-water-act>) authorizes the EPA to set primary and secondary drinking water standards. **National Primary Drinking Water standards** are enforceable by law. By law, drinking water must be less than these values. **Secondary drinking water standards** concern solutes that can negatively impact desirability (such as taste and odor). These are not enforceable *by federal law* but some states have chosen to enforce them. (U.S. primary and secondary drinking water information can be found at <http://water.epa.gov/drink/contaminants/index.cfm#List>).
- Specific types of groundwater contamination were addressed in the 1980 **Comprehensive Environmental Response, Compensation and Liability Act** (CERCLA), which will be discussed further in the next chapter.

## Naturally occurring contaminants

Water can be contaminated with by naturally-occurring solutes from the minerals in the rocks. As you learned in the Module 10, arsenic is a naturally occurring solute that had devastating effects.

Human-induced changes can alter natural flow paths and affect reactions by changing redox conditions. For example, iron oxides that commonly sorb trace metals dissolve under reducing (low oxygen) conditions. As the iron oxides dissolve the trace metals sorbed to their surface are also released into solution. Some of the metals (such as arsenic) are toxic in very small quantities. This means that unsafe concentrations of trace metals in water are more common in acidic or anoxic (no oxygen) conditions. On the other hand, minerals that form under reducing conditions such as pyrite ( $\text{FeS}_2$ ) can be oxidized when exposed to the atmosphere or oxygen-rich water. This has caused the release of arsenic during aquifer storage and recovery in the Floridan aquifer system. Another location where human changes cause reduce reactions is during mining. Lowering of the water table for mining can expose pyrite to the atmosphere. Oxidation of the pyrite forms sulfate and sulfuric acid. When the mine is abandoned and the water level rises, acidic water is released (termed **acid mine drainage**). This acidic water can have high concentrations of metals.

The most common natural threat is high **total dissolved solids**, which can make water undrinkable and unusable for agriculture. These dissolved solids may be from reactions along groundwater flow paths, or from saltwater intrusion, discussed below. In surface water and soils, evapotranspiration increases the concentration of dissolved solids by removing pure water. As a result, surface water TDS can exceed that of seawater. This is common in lakes where evaporation is the primary outflow of water (for example, terminal lakes such the Great Salt Lake in Utah or the Dead Sea in the Middle East). Irrigation of arid regions can lead to salinization of soils to the point where they can no longer be used for growing crops.

### The freshwater-saltwater interface and saltwater intrusion

The oceans has high total dissolved solids because they receive inflow from streams and groundwater that have dissolved rocks. The concentration of dissolved solids, or salinity, is increased by evaporation and reduced by precipitation of solids by organisms. Because much of the world's population lives near the coast, intrusion of saltwater is a major concern.

In coastal areas, groundwater discharges to the ocean. Because salt water is denser than freshwater, it pushes the freshwater inland and upward. As a result, a “wedge” of saltwater exists beneath the freshwater in an

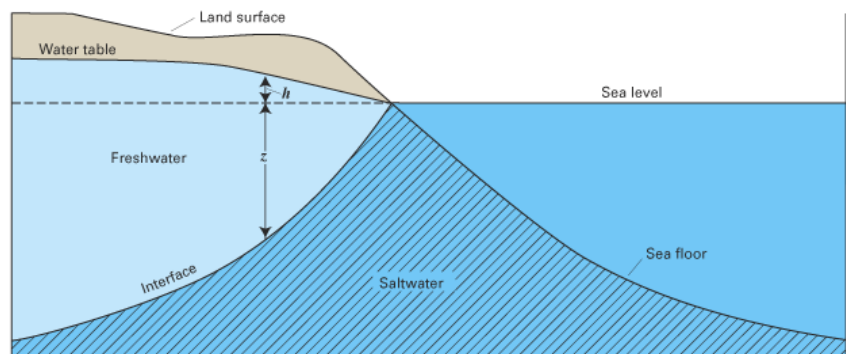



aquifer. The **Ghyben-Herzberg relationship** provides a simple means to estimate the depth to the **freshwater/salt water interface** beneath an aquifer. In the equation, the thickness of the freshwater zone above sea level is represented as  $h$  and that below sea level is represented as  $z$ , as shown in the figure below. The two thicknesses are related by

$$z = \frac{\rho_f}{\rho_s - \rho_f} h$$

where  $\rho_f$  is the density of freshwater and  $\rho_s$  is the density of saltwater

Typical ocean water has a  $\rho_s$  of  $1025 \text{ kg/m}^3$ , and typical freshwater has a  $\rho_f$  of  $1000 \text{ kg/m}^3$ . As a result  $z = 1000 / (1025 - 1000) \times h$  OR  $z = 40h$ . That means that there will be 40 ft of freshwater below sea level for every 1 ft of freshwater above sea level. The total thickness of the freshwater zone will be  $h + z$ . So if the water table is 4 feet above sea level, the interface will be 160 feet below sea level and the freshwater zone will be 164 feet thick.

The Ghyben-Herzberg method is very useful but is a simplification. In the figure above, the freshwater thickness would be zero at the shoreline. This is not realistic because it would not allow any discharge to the ocean. In reality, groundwater flow pushes the interface seaward, allowing an offshore discharge zone. The width of this zone will be proportional to the total discharge ( $Q$ ) through the aquifer. The greater the discharge, the further offshore freshwater outflow will occur.

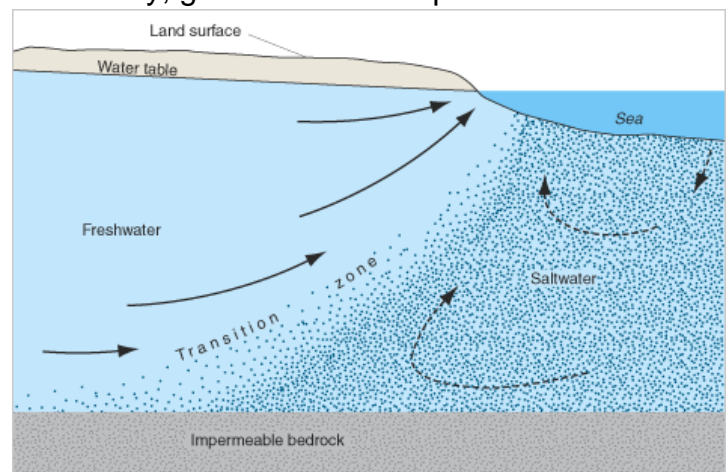

The Ghyben-Herzberg also doesn't account for the mixing between freshwater and saltwater. In real-life, there will be diffusion and mixing of water across the interface forming a **transition zone**. The interface will shift with the tides and with seasonal or longer-term changes in the aquifer discharge, mixing salt into the freshwater. As a result of diffusion and mixing, some salt will be added to the freshwater and carried out to sea. Seawater will circulate inland and upwards to replace the salt carried seaward (dashed flowlines in the figure above).

In confined aquifers, freshwater can extend beneath the ocean. The overlying confining layer helps to protect the aquifer from the denser seawater. Groundwater slowly discharges upward to the ocean through the confining layer.

Pumping reduces hydraulic head, and as a result can cause **upconing**, or a vertical rise of saltwater beneath the well. Following the Ghyben-Herzberg equation, 1 foot of drawdown can eventually lead to the interface rising 40 feet. The upconing develops

through time. Upward migration of salty water will occur more quickly in aquifers with very high hydraulic conductivity and more slowly in aquifers with moderate hydraulic conductivity.

Reduction of discharge can also allow the freshwater/saltwater interface to move laterally. The blue arrows on the figure to the right show **lateral migration** due to pumping in a semiconsolidated aquifer system. Both upconing and lateral migration of the interface are termed **saltwater intrusion**.

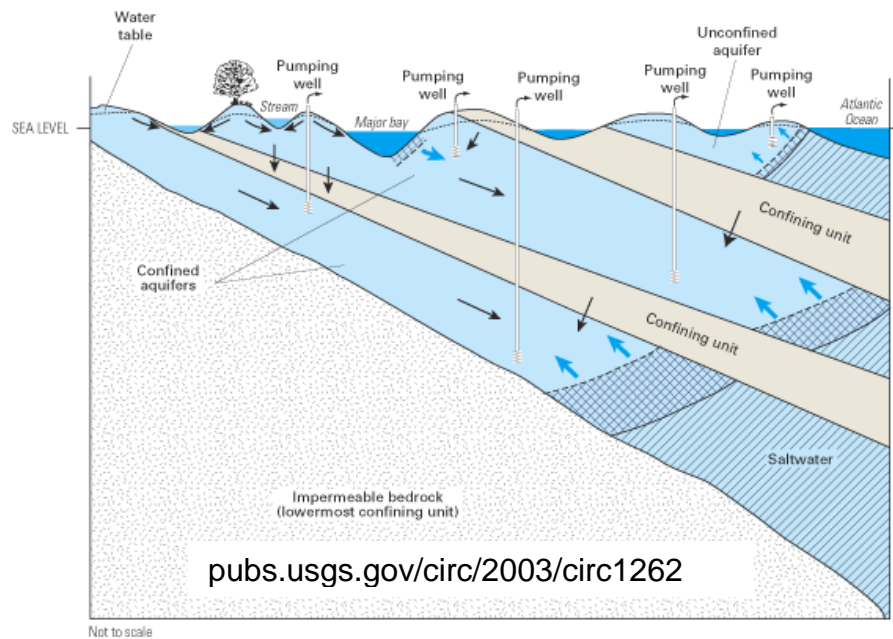
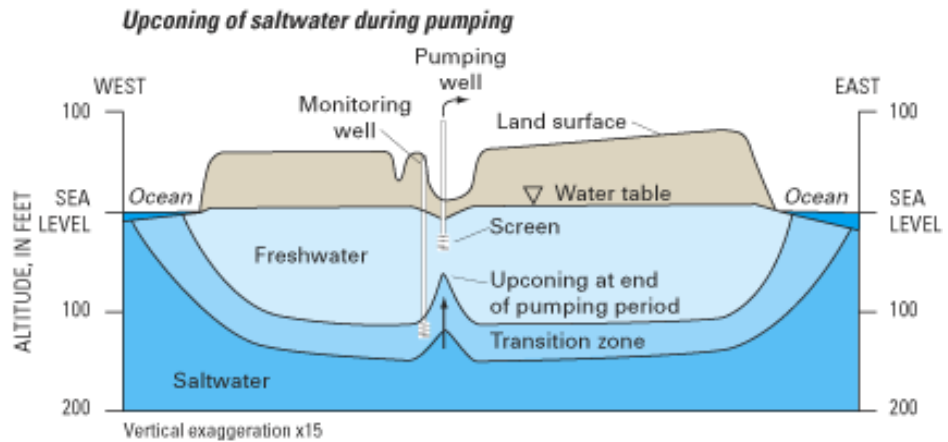

A common response to saltwater intrusion due to pumping is to develop alternative water supplies. The pumping wells can be moved inland or surface water resources used instead of groundwater. Other options include using more wells, but pumping less from each well – or using horizontal wells rather than vertical wells. Either of these methods allows collection of the water over a larger area and results in a shallower cone of depression, so less upconing. In some coastal locations, the aquifer is replenished with treated waste water or runoff to increase the hydraulic head and prevent saltwater intrusion problems. In other locations, desalinization has been selected as the best option.

For more information: See the USGS Circular 1262, where today's figures came from. It has a lot more figures, examples, and information on how saltwater intrusion is studied. <http://pubs.usgs.gov/circ/2003/circ1262/>

## Chapter 11 Water Contamination

The previous chapter mentioned major water contamination sources including **waste from Animals/Humans, agriculture/lawns, and industrial sites**. These types of contamination sources affect surface water and can be carried to the water table with infiltration. Below are additional contamination sources that are particularly important to groundwater.

**Leaky underground storage tanks.** Underground storage tanks (USTs) are used for storage of petroleum products and other liquid chemicals. Before the 1980s, these were frequently constructed of unlined steel, and the tanks often corroded and leaked. Small leaks went undetected and resulted in groundwater contamination. Many of these UST leaks occurred at gas stations. Gasoline is a mixture of chemicals. One of the more hazardous chemicals, benzene, makes up 2% of gasoline. The drinking water standard for benzene is 5 parts per billion (one ppb is about 1 drop of benzene in a tanker truck full of water). In Florida alone, over 26,000 underground storage tank leaks have been confirmed and only 13,000 cleanups have been completed (<http://www.epa.gov/oust/states/fl.htm>). Since the problem was discovered, most plain steel tanks have been removed. New tanks are constructed to be more leak-resistant through corrosion protection, non-metal construction, or a non-metal liner. Spill prevention measures and leak detection are also required by the EPA.

**Faulty septic systems** can be a common cause of groundwater contamination. If the sediment or rock beneath the drain field is too permeable, waste water enters the water table too quickly. There will not be enough time for aerobic microbial activity to break down any organic material or use remaining nutrients. Karst aquifers are particularly vulnerable to septic tank contamination because of conduits formed by dissolution. Problems with septic tanks can also arise where the water table is high. Again, there would not be sufficient time for aerobic microbial activity. In some cases, homeowner may be required to raise the land surface by adding a foot or two of sediment before installing a septic tank and drainfield.

**Landfills** In the past, household and industrial waste was often dumped into holes in the ground and then covered. In karst regions, sinkholes were sometimes treated as convenient holes. Infiltrating water flowing through the landfill waste creates **leachate**, as the water dissolves soluble material in the garbage. This leachate can then flow to groundwater and possibly to surface water. Landfills currently are better constructed than the “dumps” used in the past. Engineered landfills often have a constructed low-permeability liner at the base to prevent leachate from reaching the water table. Leachate is collected and treated, and landfill cells (packets of waste) are capped with low permeability material to prevent infiltration. There are still many improperly constructed landfills and “dumps” remaining that create persistent contamination

problems. Contamination from landfills depends on what was disposed. Contaminants can include trace metals such as lead, cadmium or mercury.

### Aquifer vulnerability

Because most contaminant sources are on or near surface, the vulnerability of aquifers depends on:

- the depth to the water table. Greater water table depth means longer times in the unsaturated zone, which slows contaminants and can allow microbes to break down some contaminants.
- The amount of recharge. High recharge rates carry contaminants to groundwater more quickly.
- Unsaturated zone hydraulic conductivity. The higher the K, the faster contaminants reach the water table.
- hydraulic conductivity of overlying confining layers (if a confining layer exists). A confining layer can help slow down contaminants so that it takes longer for them to reach the aquifer.

### Contaminant Movement

As a dissolved contaminant flows with the water (called **advection**), it will also spread. This spreading is due to water flow branching around the solid grains. In addition, some flow pathways are faster than others. This spreading of the dissolved contaminant is called **dispersion**. As a result of advection and dispersion, a contaminant **plume** is created.

Contaminant plume migration will be controlled by the velocity of the water. In the two figures below, the contours show hydraulic head. The aquifer is isotropic, so advection carries the dissolved contaminant perpendicular to the contours. If there is a continuous source of contamination (such as a barrel that slowly leaks over an extended time) the plume will stretch from the source downgradient. Dispersion and diffusion cause the plume to spread in the flow direction and transverse to the flow direction.

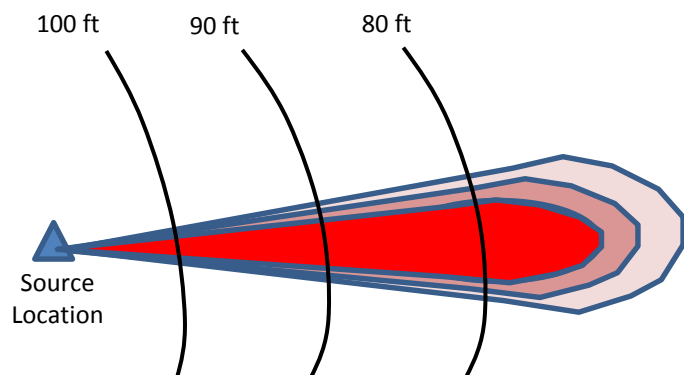

If there was a one-time source of contamination, such as a spill, the plume will migrate downgradient from the source area. The location of the center of mass of the plume can be calculated based on the velocity of groundwater flow.

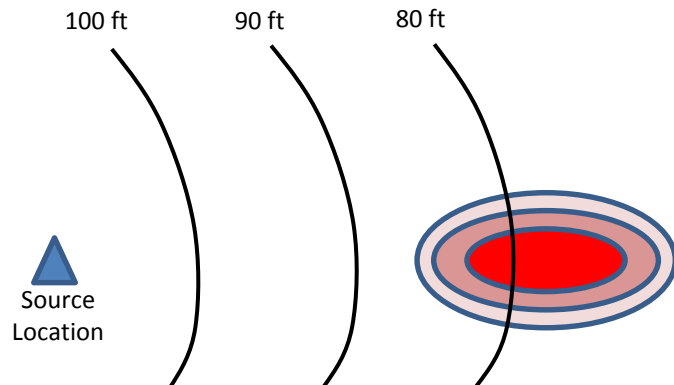

Some contaminants, particularly those that don't dissolve easily, will attach to (or within) solids (**sorption**). This will slow down migration of the plume relative to the groundwater flow velocity.

A liquid that does not dissolve easily can flow on its own, in a separate phase from the groundwater. This is called a **non-aqueous phase liquid (NAPL)**. There are two types of NAPLs: those that are less dense than water (**LNAPL**) and those that denser than water (**DNAPL**). Gasoline is an example of a LNAPL and creosote (such as at the Cabot-Koppers site, TCE, DCE, PCE are all examples of contaminants that tend to form DNAPLs.

Both LNAPLs and DNAPLs will move downwards in the unsaturated zone, due to gravity. Like water, they will be attracted to solids by capillary forces. As a result, residual NAPL will be left behind as the NAPL migrates downward. Once at the water, the NAPL and the water remain separate. The water only flows through its portion of the pore space and the NAPL flows in its portion. Because the water and NAPL compete for the same pore space, the presence of one fluid "blocks" flow of the other fluid. That means that the **relative permeability** of the aquifer for NAPL flow will be less than its total permeability unless the NAPL can fill the entire pore space. Why is this important? As the NAPL moves through the saturated zone, residual NAPL can remain "stuck" in the pore spaces. This makes clean-up of NAPLs very difficult.

Due to their low density relative to water, LNAPLs will tend to remain near the water table. It will get carried up and down as the water table rises and falls. If an LNAPL were somehow introduced to a confined aquifer, it would rise upward until it reached the confining layer.

DNAPLs move downward due to their density. The groundwater flow might “nudge” the DNAPL a little in the flow direction but does not control the DNAPL flow. DNAPLs tend to pond on top of clay layers because they have difficulty entering small, water-filled pore

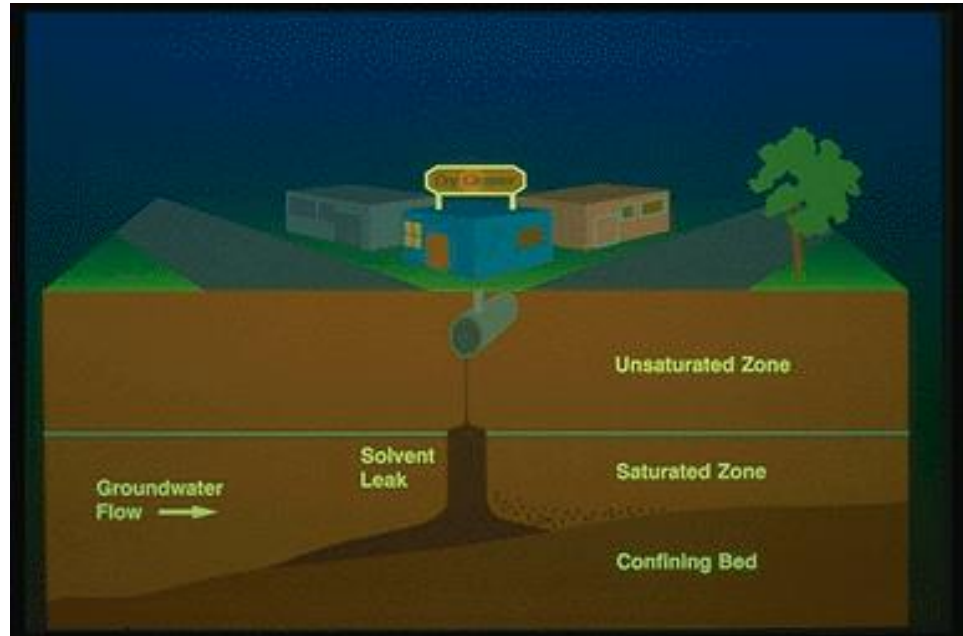

spaces due to capillary attraction between the water and the sides of the pores. Depending on the geometry of the clay layer, DNAPLs can even move opposite the direction of groundwater flow (Figure from epa.gov). This can make DNAPLs extremely difficult to find and to clean up.

## Groundwater Remediation

Several high-profile discoveries of contamination in the late 1970s and early 1980s triggered legislative action. These sites included the Love Canal Site in upstate New York and the Woburn Site in Massachusetts. The cost of cleaning up industrial contamination sites is very high, and companies may have gone out of business in the years since the problem began. Until the 1980s there was no mechanism to assess industries for contamination clean-ups. In 1980, the Comprehensive Environmental Response, Compensation and Liability Act (CERCLA) was established by Congress. This act is nicknamed **Superfund**.

One of the important aspects of Superfund is that it designated potentially responsible parties (PRPs) to pay for the costs of waste removal and site remediation. PRPs could include the current land owner or operator, the owner/operator at the time of waste disposal, waste transporters, or those who arranged the disposal or transport. If a PRP could not be found (or could not pay), Superfund included a tax on hydrocarbon and chemical companies for these “orphan” sites. This tax was ended in 1995 and after the remaining money ran out, funds were allocated by Congress in the yearly budget.

The Superfund process is very lengthy and includes:

- **Preliminary Assessment/Site Inspection.** In this step, the site and its history are evaluated. If there is immediate threat, it is addressed by emergency actions.
- If the site poses a sufficiently high hazard, it is added to **National Priorities List (NPL).**
- After the site is listed, a **Remedial Investigation** determines the nature and extent of contamination and a **Feasibility Study** assesses the treatability of site contamination and evaluates treatment technologies. Some clean-up may occur in this phase to limit off-site migration of the contaminant.
- When the studies are complete, a **Record of Decision** explains which cleanup alternatives will be used at NPL sites.
- In the **Remedial Design/Remedial Action** phase, plans and specifications for applying site remedies are prepared. The bulk of the cleanup usually occurs during this phase.
- The next two milestones are the completion of construction (if any) and the Post Construction (or clean-up) completion
- Once no further response is necessary or it has been determined that the site does not pose a danger, it is deleted from the National Priority List
- If feasible, the site is available for re-use.

**Superfund addresses only the highest priority hazardous waste sites.** Other sites, such as the many gas stations with leaking underground storage tanks, may be addressed by local authorities.

The liability in the Superfund legislation had some negative consequences; because it discouraged purchase or development of land with possible past contamination. To address this problem, the 1986 *Superfund* Amendments and Reauthorization Act (SARA) included a defense for “Innocent Landowners” who bought the land with no knowledge of a contamination problem. The purchaser needs to prove that they made “reasonable inquiries”, such as through a pre-purchase environmental site assessment. **Brownfields** legislation (mid-1990s) provided additional types of liability release and some tax incentives for development of abandoned or underused industrial sites.

### **Site Investigations**

The first step for investigation of any site is to establish the site history including any documented or remembered chemical use, transport, or storage on site. Air photos may help in this investigation. Shallow soil samples may be collected and adjacent surface water or existing wells may be sampled.

If preliminary work indicates subsurface contamination, the vertical and horizontal extent of contamination is investigated. This includes both the unsaturated and saturated zone. **Soil gas sampling** is used in the unsaturated zone. A probe is drilled or pushed into the ground and the soil gas is vacuumed out of the ground and analyzed. Soil samples are also analyzed to look for sorbed or residual contaminants. Water samples are collected to be analyzed for dissolved contaminants. During the investigation, the underground geology is described during drilling, and cross-sections are drawn to understand the distribution of aquifers and confining units.

Often investigations start near the suspected source and expands downgradient to find out how far the contaminant has travelled. Often, the drilling and sampling will continue downgradient until uncontaminated water is found. To determine where the contaminant has travelled in the past and where it will move in the future, potentiometric surface maps are drawn to establish flow directions. Heterogeneity can be very important. For example, if contaminants reach a karst cave system (in limestone) or an old channel deposit (in alluvial deposits), they can move very quickly. If the groundwater flow is very complex, computer modeling of groundwater flow can help to predict what surface water or pumping well is likely to receive the contaminated water.

Investigations also assess the likelihood of non-aqueous phase liquids. Sometimes the drilling happens to sample a NAPL, but more often the NAPL is inferred from very high concentrations of a contaminant and from the site history

### **Source removal or control**

The first step in cleaning up a site is often **source removal or control**. Some on-site waste may still be in drums that need to be removed. Contaminated soils can be excavated and either treated (by incineration or allowing the contaminants to volatilize) or removed for disposal. In many cases, removal of the contaminants creates more of a hazard, and the waste remains but is isolated from the surroundings (**source control**). Soils can be mixed with cement to **solidify** the waste. **Surface seals** above the waste prevent recharge from dissolving the contaminants and carrying it to the water table. Physical barriers such as cement walls can help prevent the contamination from moving downgradient. Collection systems or drains may be put in to capture any runoff or infiltrated water.

### **Unsaturated zone**

Contamination moving in the air of the unsaturated zone may be removed by **soil vapor extraction**, in which the soil gas is pumped from unsaturated zone and treated.



Heating of the unsaturated zone (**thermal destruction**) can speed up volatilization of any remnant contaminant on the solids.

### **Saturated zone**

For contamination near the water table, **air sparging** consists of pumping air into the saturated zone and collecting air (+contaminants) from unsaturated zone.

The most common approach to remediating dissolved contamination below the water table is called **pump and treat**. Wells pump out contaminated water, which is treated and the treated water is either disposed or re-injected. Treatment methods include air stripping (allowing the contaminant to volatilize), running the water through activated carbon filters, or using microbes to break down the contaminant.

There are several problems with pump-and-treat. The first is that aquifer **heterogeneities** can reduce effectiveness. The contaminants may have had years or decades to slowly migrate or diffuse into low-permeability sediments or rocks. The pumping cleans up the water quickly in the high permeability rocks, but the contamination can be hard to remove from low-permeability rocks. Another problem is created by **sorption**. As the contaminated water becomes cleaner, sorbed contaminants will start to desorb and re-contaminate the groundwater. Finally, **undiscovered NAPLs** can provide ongoing source. The water never gets completely clean because there is always more dissolving.

As a result of these problems with pump and treat, it is not feasible to clean up some sites. As a result, the focus at some sites has shifted to **containment** rather than remediation. The pumping may need to continue indefinitely just to keep the contaminant from migrating further downgradient. This is termed **hydraulic control**.

### **Other remediation alternatives**

Some types of contaminants, such as gasoline or other hydrocarbons, can be effectively broken down by microbes. In **bioremediation**, the microbes can be encouraged providing nutrients and/or oxygen to enhance microbial activity. **Monitored natural attenuation** also uses microbial action to “treat” contamination, but does not involve addition of anything. It just requires letting natural processes treat the groundwater and verifying that processes are effective. Obviously treatment costs are lower than for other forms of remediation but detailed investigation and monitoring are needed.

More information at

<http://epa.gov/superfund/about.htm>

If you are curious about sites in your home town, you can create a map at:

<http://iaspub.epa.gov/apex/cimc/f?p=255:63:7581597377802019>

## Ch 12 Karst and Sinkholes

Underground caves form from dissolution of soluble rock such as limestone or dolostone. The details of how and where dissolution occurs and caves form is a subject of active research. Most caves are thought to form at or just below the water table. These dissolution from the infiltration of rainwater are called **epigenic**, meaning that it occurs in the upper layer, or “skin” of the karst. As recharge reaches the water table, it carries carbon dioxide from the air and from decay of organic matter in the soil. This forms carbonic acid which dissolves the calcite. Once recharge reaches the water table, it may move slightly downward but generally flows horizontally in aquifers. As a result, water-table caves are generally nearly horizontal.

Water table caves tend to have an elliptical tube shape. Like surface water streams, caves can be organized, with smaller cave system “tributaries” flowing into larger caves, and the largest cave system discharging at a spring. Cave formation can cause the breakdown of the overlying cave roof, so often large boulders are found within caves. Because the water table shifts through geologic time, there can be multiple levels of caves.

Above the water table, vertical caves can grow due to recharge infiltrating downward through fractures. The infiltrating water is generally undersaturated with calcite, so dissolution expands the fractures. The resulting vertical caves provide water to the water-table caves. Vertical fractures often start at the top of the limestone (or other soluble rock), and this region at the top of the limestone is called the **epikarst**.

Caves can also form where streams flow onto an unconfined (or poorly confined) karst aquifer from another, less soluble rock or sediment type. As the river water flows into small fractures, it can form a swallet or siphon, meaning a location where surface water sinks underground. With time, the cave system can become large enough that the stream completely disappears underground. The Santa Fe River in Florida disappears into a River Sink and re-emerges several miles away at a spring called River Rise.

In contrast to epigenic caves, formed by undersaturated water moving downward from the land surface, **hypogenic** caves where groundwater flowing upward from depth contains hydrogen sulfide. As this water mixes with oxygen-rich water, sulfuric acid is formed. This sulfuric acid dissolves the limestone. Well-known examples of hypogenic cave systems include Carlsbad Caverns and Lechuguilla Caves in New Mexico. The location of the cave passages are controlled by vertical fractures that allow the upward escape of water from lower, confined aquifers.

With enough time and contact with calcite, water flowing through limestone can eventually become saturated with calcite and can dissolve no more. However, saturation state is very sensitive to the concentration of carbon dioxide dissolved in the water. As saturated water from greater depths flows onto the land surface or into an underground cave above the water table, the carbon dioxide in the water can escape. As a result of the drop in carbon dioxide concentration, the water becomes oversaturated, and calcite can precipitate. Changes in temperature can also cause a solution to change from undersaturated to oversaturated. When the water is oversaturated with calcite, **speleothems** such as stalactites and stalagmites grow through time.

## Sinkholes

**Sinkholes** are depressions in the land surface created by underground dissolution. Sinkholes are generally related to epigenic processes – in other words from the infiltration of undersaturated water.

There are several types of sinkholes. **Dissolution sinkholes** (to the right) form gradually where the ground surface lowers as the rock dissolves. In this case, there really isn't a "cavity" that forms underground. Dissolution sinkholes occur where the soluble rock is near the surface.



**Cover subsidence** sinkholes are also gradual, and form as sands above the soluble rock trickle into the underground cavity as it forms.

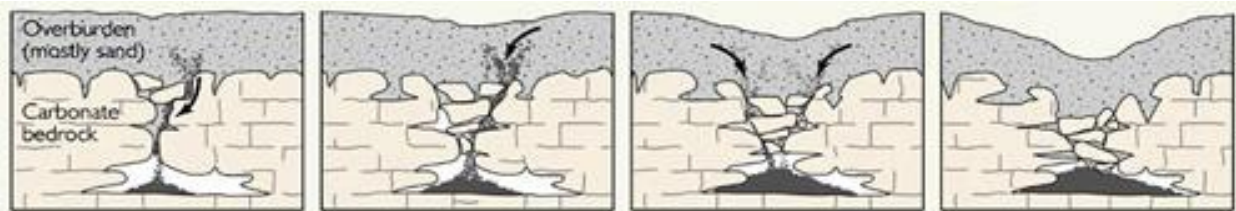

**Cover-collapse sinkholes** form when the sediment or rock above the cavern are cohesive enough to create a roof above the cavity. When this roof can suddenly no longer be supported and the cover suddenly collapses into the cavity.

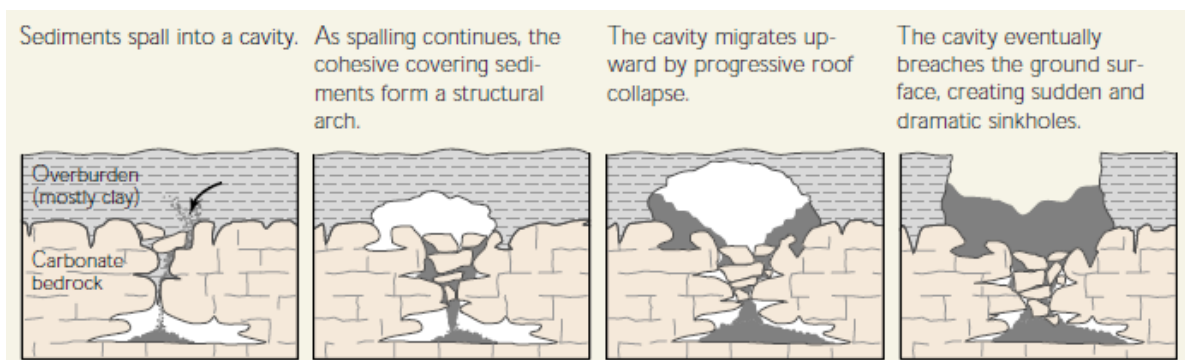

Humans can contribute to the formation of underground cavities by:

- focusing runoff into a location
- creating acidic conditions that enhance dissolution.

Humans can trigger collapse of underground cavities by:

- adding weight (such as buildings) to the land surface.
- Lowering of the water table can also trigger collapse sinkholes, because removing the water can decrease the support for the cavity's cover (by increasing effective stress).

In areas without soluble rocks, sinkholes can be created by the collapse of the land surface into a mine or by the underground break of a water main or gas pipe that creates a cavity underground.

### **Hydrogeology of Karst aquifers**

Karst aquifers can be extremely vulnerable to contamination because of rapid flow through conduits. Finding good locations for landfills or industrial sites can be very difficult because of the difficulty in avoiding sinkholes and conduits. Similarly, water from septic systems can move through dissolution channels directly to the water table with no time for microbial action in the unsaturated zone. Spills or industrial leaks can move rapidly from the source area through cave systems.

Because of the rapid flow in caves, it is important to know where they are. Some of the cave systems below the water table can be mapped by cave divers. Cave divers can also provide information on which direction and how fast the flow is moving. However, exploring new caves is time-consuming and dangerous, and water can enter passages too small for humans. Where humans can't swim, a **tracer test** can help to determine flow paths. Fluorescent dyes are most commonly used, so this type of test is called a **dye trace**. To conduct a dye trace, the dye is injected into a sinking stream or a well, or is released into a cave by a diver. At suspected discharge locations (such as springs), water samples are collected. The concentration of the dye is measured with a fluorometer, which is sensitive enough to detect dye even when it cannot be seen with the eye

Dye trace studies can confirm which karst features are connected and provide travel times, but cannot indicate the exact underground flow path. Challenges of dye trace studies are that you might be sampling in the wrong discharge location for the dye and miss a discharge point. In addition, you can spend a long time waiting for the dye to reappear because the travel time is not yet known. Use of charcoal packets helps with this issue. These packets can be placed in the water to collect the dye over a long

period (the dye sorbs on the charcoal). After the packet is removed, an alcohol solvent is used to extract the dye from the charcoal so it can be measured.

### **Other methods to map caves**

Other than human exploration or tracer studies, underground caves can be mapped using observations during drilling. The drill bit will suddenly drop when it reaches a cave. Several geophysical methods can also help to “see” underground caverns because the properties of air or water-filled caves are very different from rocks. For example, seismic waves move much more slowly through water (or air) than rock, electricity travels more quickly through water than rock, and the gravitational pull of solid rock is greater than that of rocks with caves. As a result, geophysical surfaces can help to identify locations with underground caverns.

It is also sometimes possible to identify likely cave locations using detailed water table maps. Because caves transmit flow easily, they often create low “troughs” in the water table.

For more information:

<http://www.agiweb.org/environment/publications/karst.pdf>

<http://pubs.usgs.gov/of/1997/0536a/report.pdf>